

SME30GWUU NB

Linear bushing, case unit

TYPE: Shaft guidance systems, Linear bushing, case unit, Open type, Double-wide block type, Type SME..W, Standart (NB)

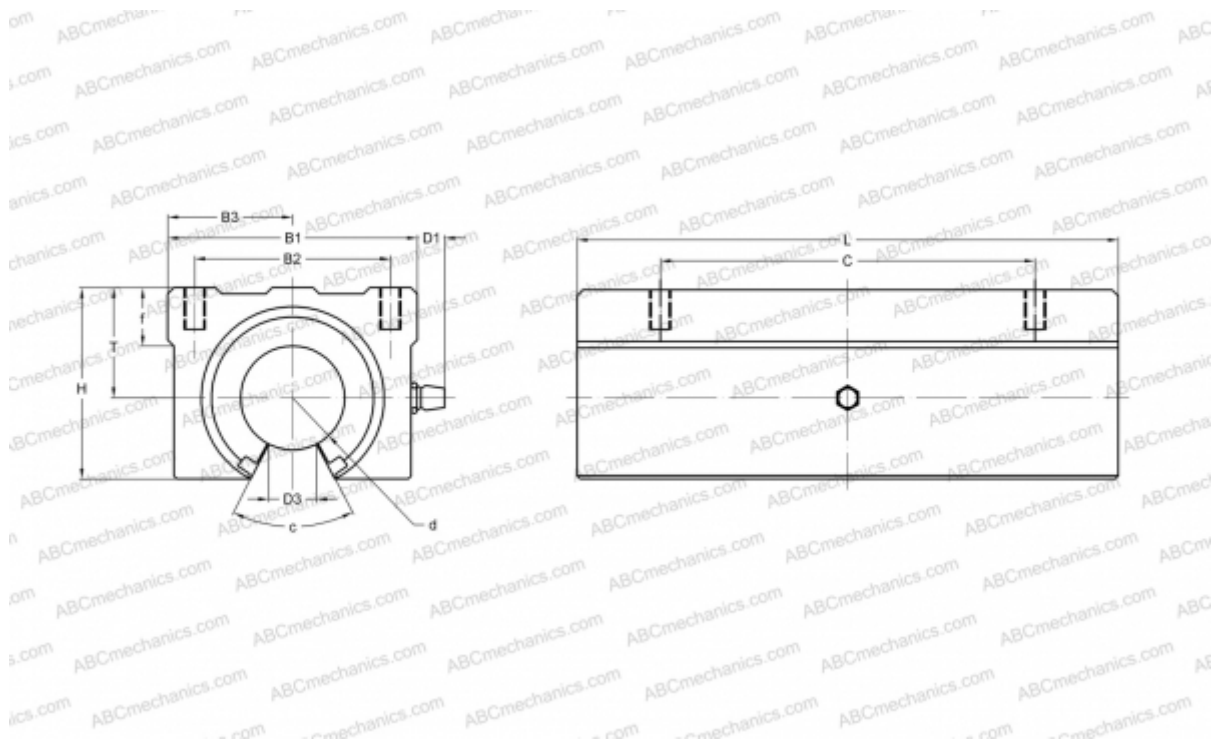

Technical specification

DIMENSIONS, MM

B1	70,000
H	56,000
L	140,000
d	30,000
D1	7,500
D3	14,000
B2	50,000
B3	35,000
T	33,000
f	15,000
C	100,000
c	50

WEIGHT, KG 1,260

MANUFACTURER [NB](#)