

## SMSE10GWUU NB

Linear bushing, case unit

TYPE: Shaft guidance systems, Linear bushing, case unit, Open type, Double-wide block type, Type SME..W, Corrosion resistance (NB)

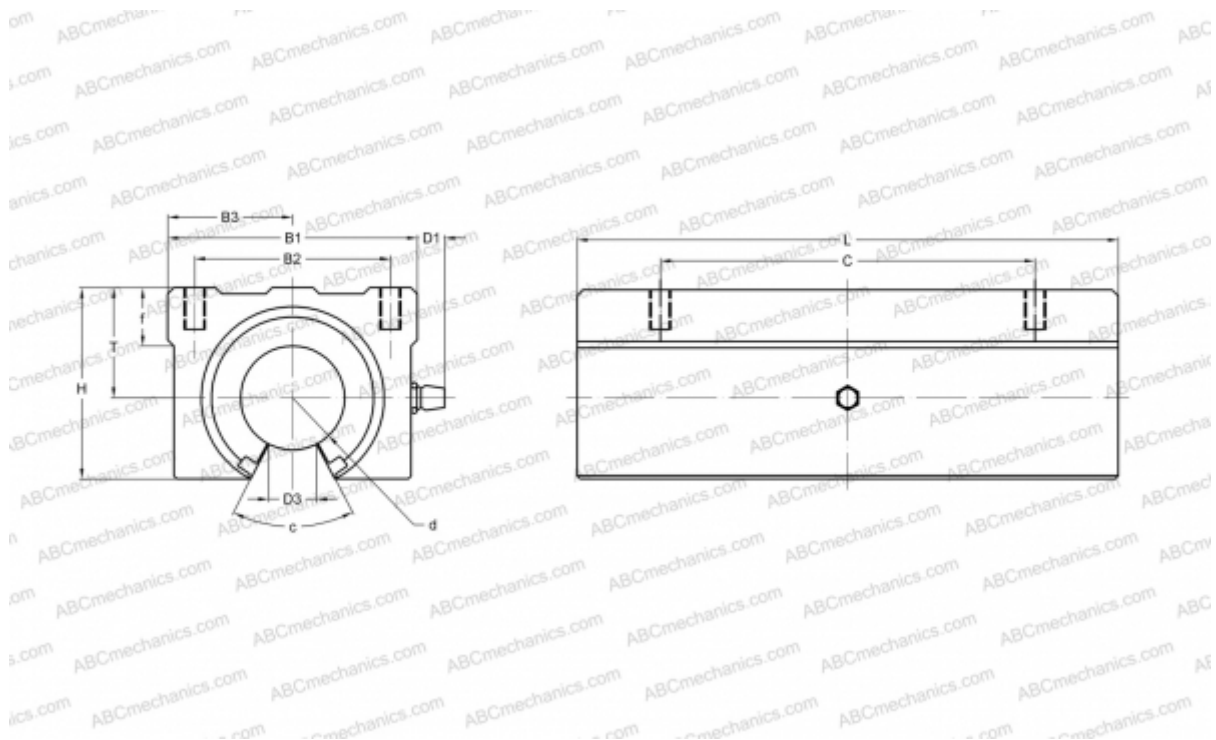

### Technical specification

#### DIMENSIONS, MM

B1	36,000
H	24,000
L	65,000
d	10,000
D1	7,500
D3	6,000
B2	25,000
B3	18,000
T	15,000
f	7,000
C	40,000
c	80

**WEIGHT, KG** 0,140

**MANUFACTURER** [NB](#)