

SMSE16GWUU NB

Linear bushing, case unit

TYPE: Shaft guidance systems, Linear bushing, case unit, Open type, Double-wide block type, Type SME..W, Corrosion resistance (NB)

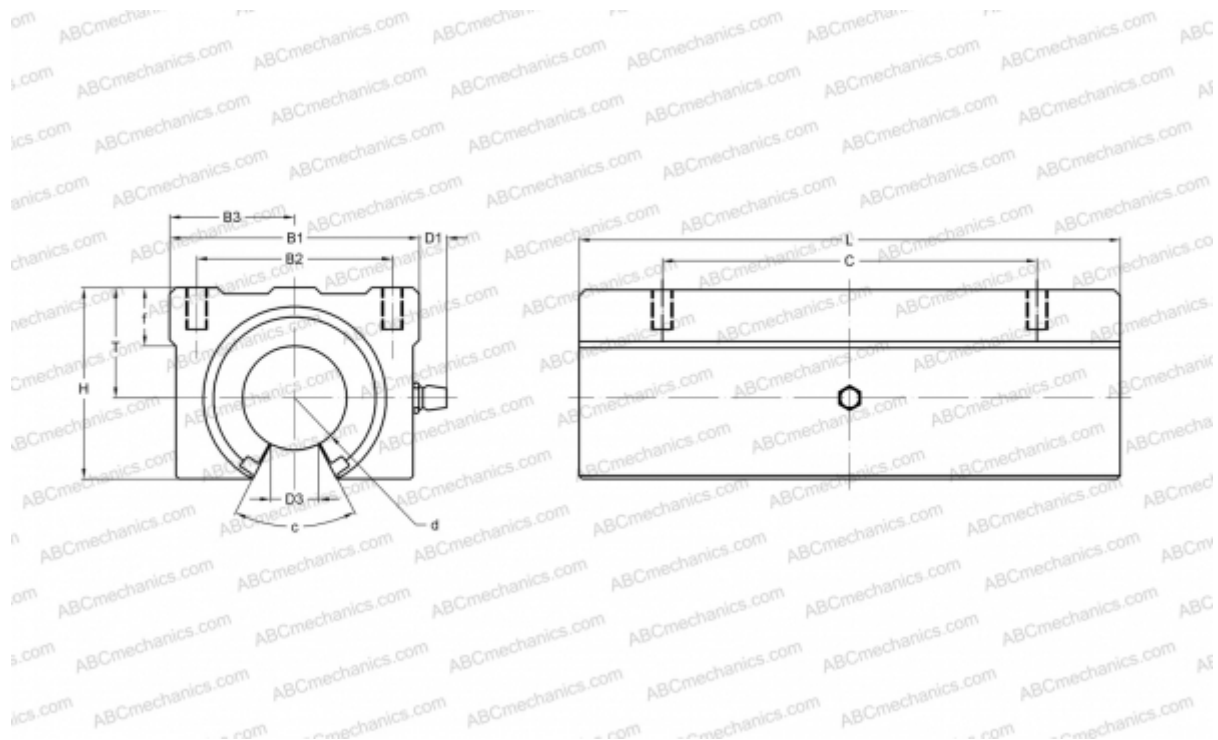

Technical specification

DIMENSIONS, MM

B1	45,000
H	33,000
L	85,000
d	16,000
D1	7,500
D3	10,000
B2	32,000
B3	22,500
T	20,000
f	9,000
C	60,000
c	80

WEIGHT, KG 0,300

MANUFACTURER [NB](#)