

## SMSE20GWUU NB

Linear bushing, case unit

TYPE: Shaft guidance systems, Linear bushing, case unit, Open type, Double-wide block type, Type SME..W, Corrosion resistance (NB)

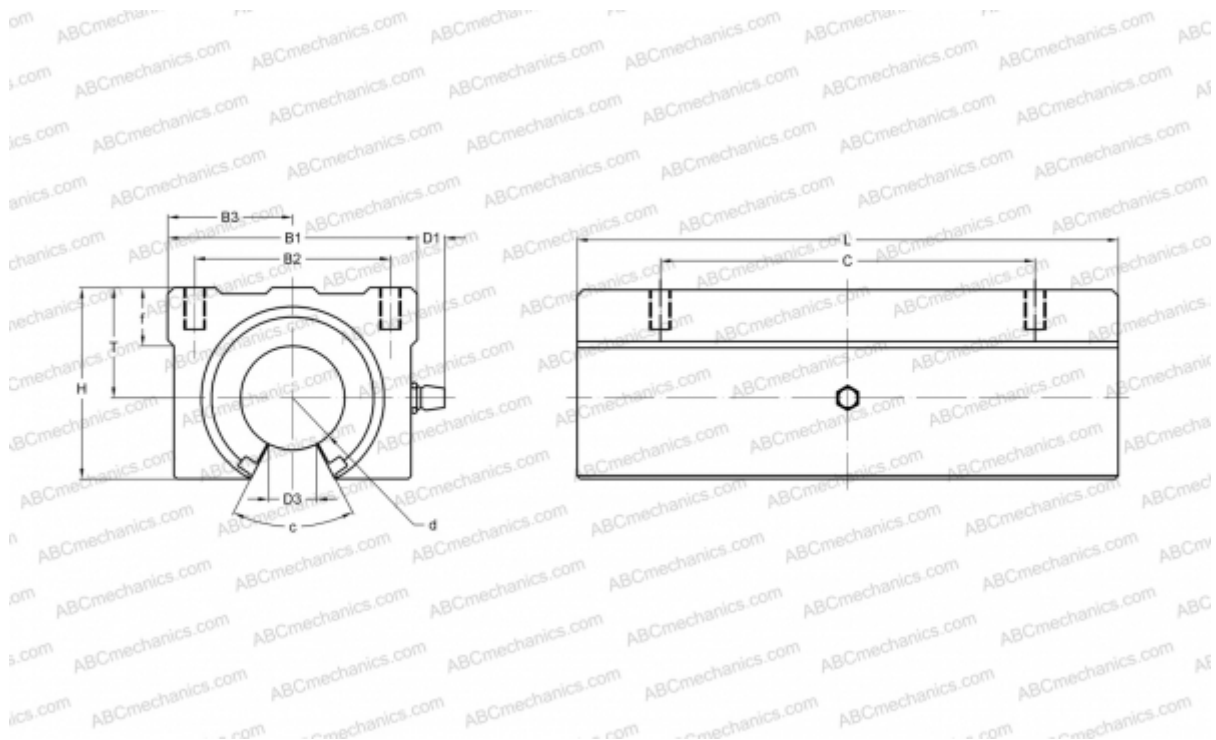

### Technical specification

#### DIMENSIONS, MM

B1	48,000
H	39,000
L	95,000
d	20,000
D1	7,500
D3	10,000
B2	35,000
B3	24,000
T	23,000
f	11,000
C	70,000
c	60

**WEIGHT, KG** 0,400

**MANUFACTURER** [NB](#)