

SMD30GUU NB

Linear bushing, case unit

TYPE: Shaft guidance systems, Linear bushing, case unit, Open type, Clearance adjustable type, Type SMD, Standart (NB)

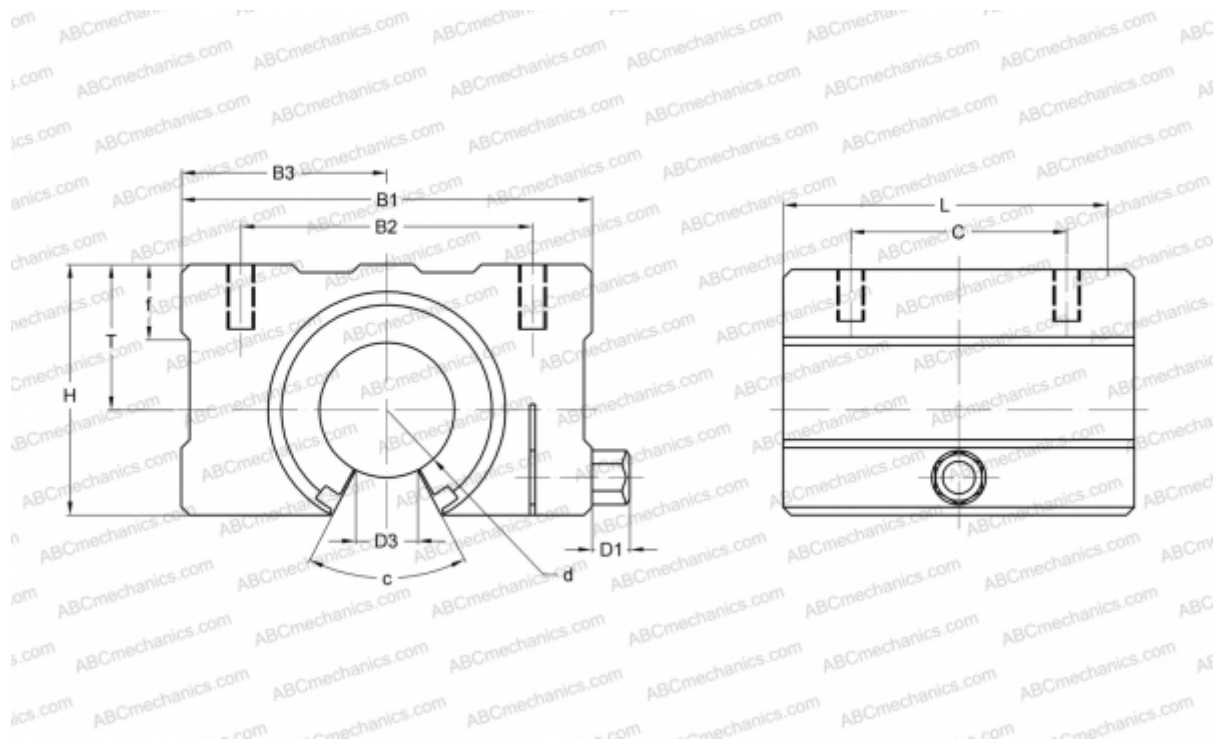

Technical specification

DIMENSIONS, MM

B1	78,000
H	56,000
L	70,000
d	30,000
D1	7,000
D3	14,000
B2	58,000
B3	39,000
T	33,000
f	15,000
C	50,000
c	50

WEIGHT, KG 0,720

MANUFACTURER [NB](#)