

## RBW 8 NB

Linear bushing, case unit

TYPE: Shaft guidance systems, Pillow block, Type RBW, resin, inch size (NB)

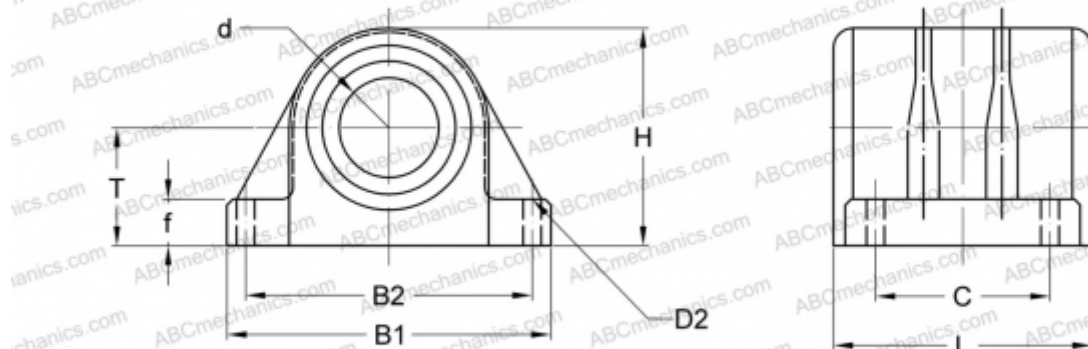

### Technical specification

#### DIMENSIONS, MM

B1	50,800
H	31,750
L	40,481
d	12,700
D2	4,000
B2	42,875
T	17,450
f	8,731
C	25,400

**WEIGHT, KG** 0,051

**MANUFACTURER** [NB](#)