

## SMP16GUU NB

Linear bushing, case unit

TYPE: Shaft guidance systems, Pillow block, Type SMP (NB)

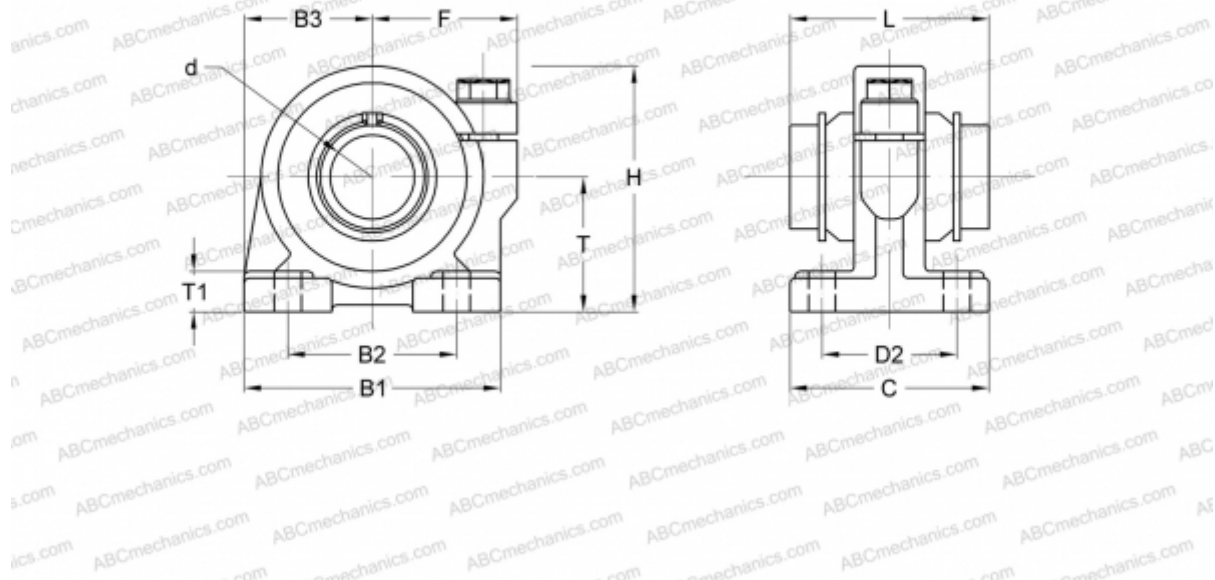

### Technical specification

#### DIMENSIONS, MM

B1	55,000
H	53,000
L	37,000
d	16,000
D2	29,000
B2	35,000
B3	27,500
T	29,000
T1	10,000
C	40,000
F	32

**WEIGHT, KG** 0,380

**MANUFACTURER** [NB](#)