

## SMP35GUU NB

Linear bushing, case unit

TYPE: Shaft guidance systems, Pillow block, Type SMP (NB)

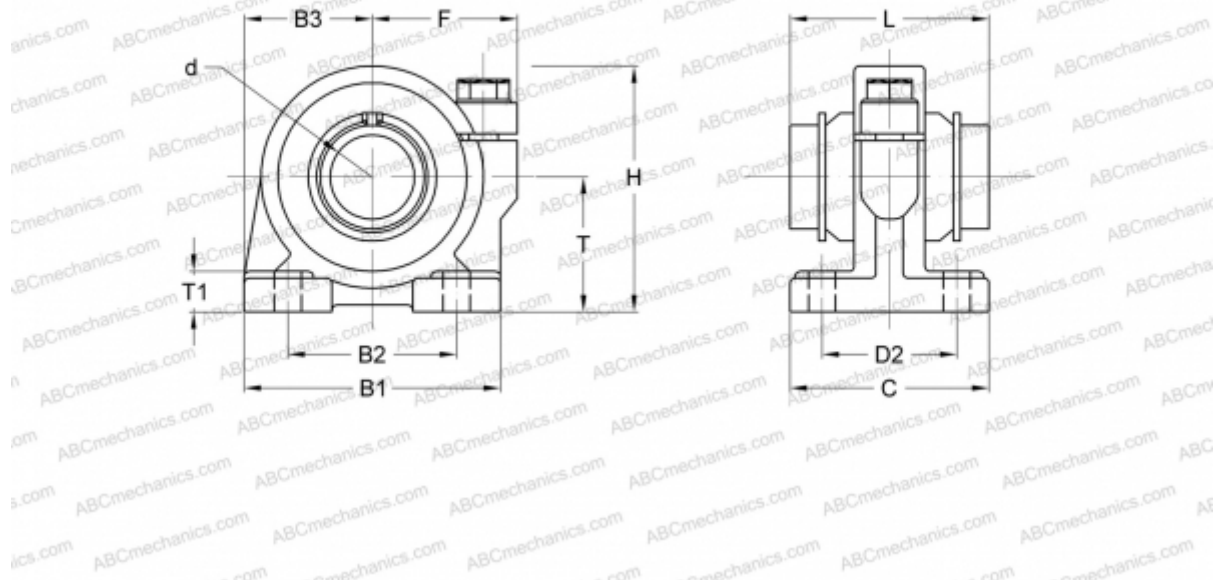

### Technical specification

#### DIMENSIONS, MM

B1	98,000
H	94,000
L	70,000
d	35,000
D2	53,000
B2	62,000
B3	49,000
T	50,000
T1	15,000
C	76,000
F	58

**WEIGHT, KG** 2,100

**MANUFACTURER** [NB](#)