

## SMP50GUU NB

Linear bushing, case unit

TYPE: Shaft guidance systems, Pillow block, Type SMP (NB)

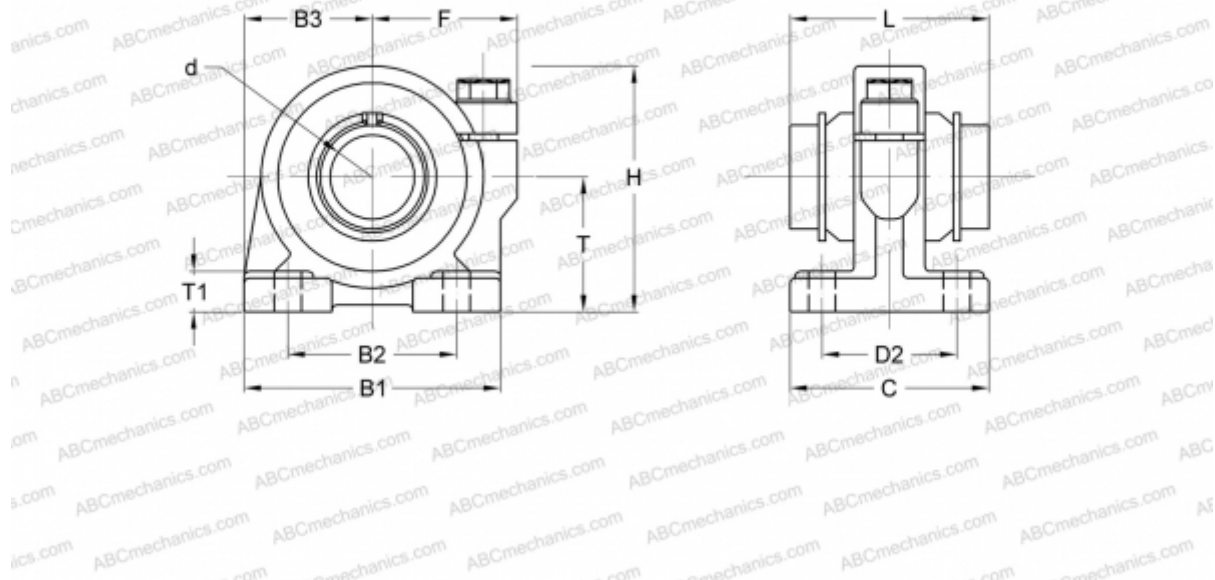

### Technical specification

#### DIMENSIONS, MM

B1	144,000
H	134,000
L	100,000
d	50,000
D2	70,000
B2	100,000
B3	72,000
T	70,000
T1	20,000
C	105,000
F	80

**WEIGHT, KG** 6,100

**MANUFACTURER** [NB](#)