

TRT 20GUU NB

Linear bushing

TYPE: Shaft guidance systems, Linear bushing, With flange, Oval type, three length, Type TRT (NB)

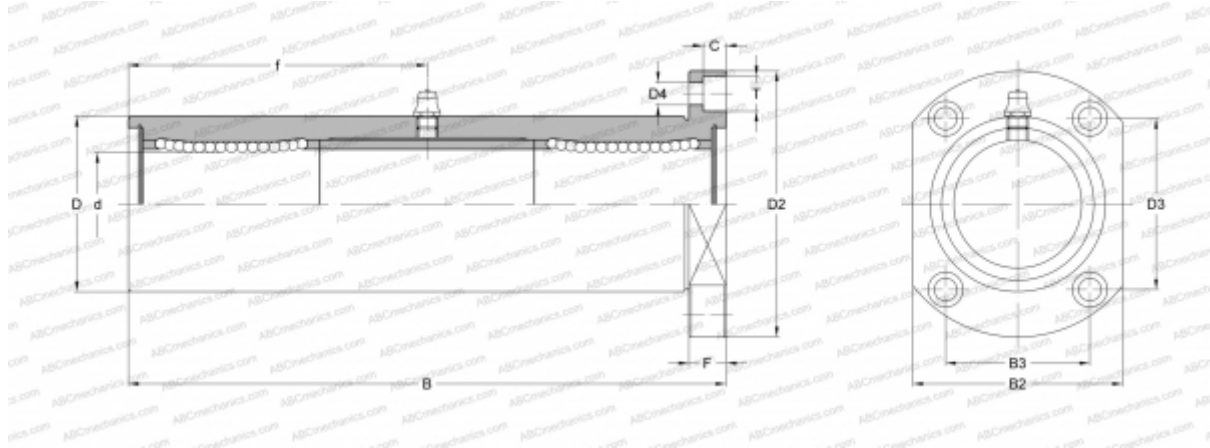

Technical specification

DIMENSIONS, MM

d	20,000
D	40,000
B	118,000
D2	62,000
D3	40,000
D4	5,500
B2	46,000
B3	32,000
T	9,000
f	59,000
C	5,100
F	8

MANUFACTURER

[NB](#)