

SM 6G-LUU NB

Linear bushing

TYPE: Shaft guidance systems, Linear bushing, Standard, Close type, Type SM..G-L, long (NB)

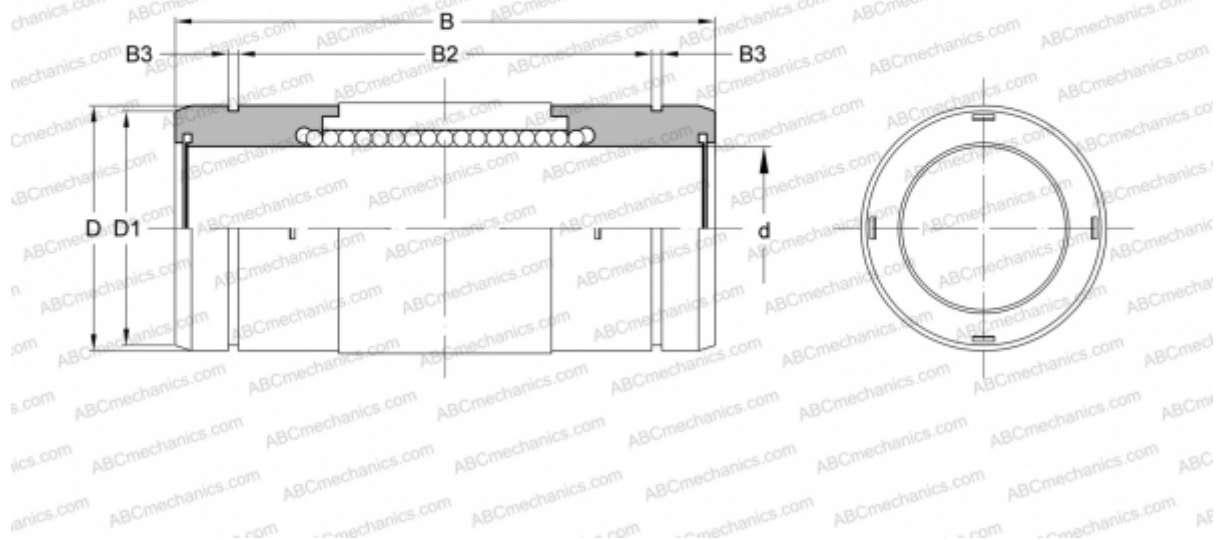

Technical specification

DIMENSIONS, MM

d	6,000
D	12,000
B	26,000
D1	11,500
B3	1,000

WEIGHT, KG 0,010

MANUFACTURER [NB](#)