

SM 8G-LUU NB

Linear bushing

TYPE: Shaft guidance systems, Linear bushing, Standard, Close type, Type SM..G-L, long (NB)

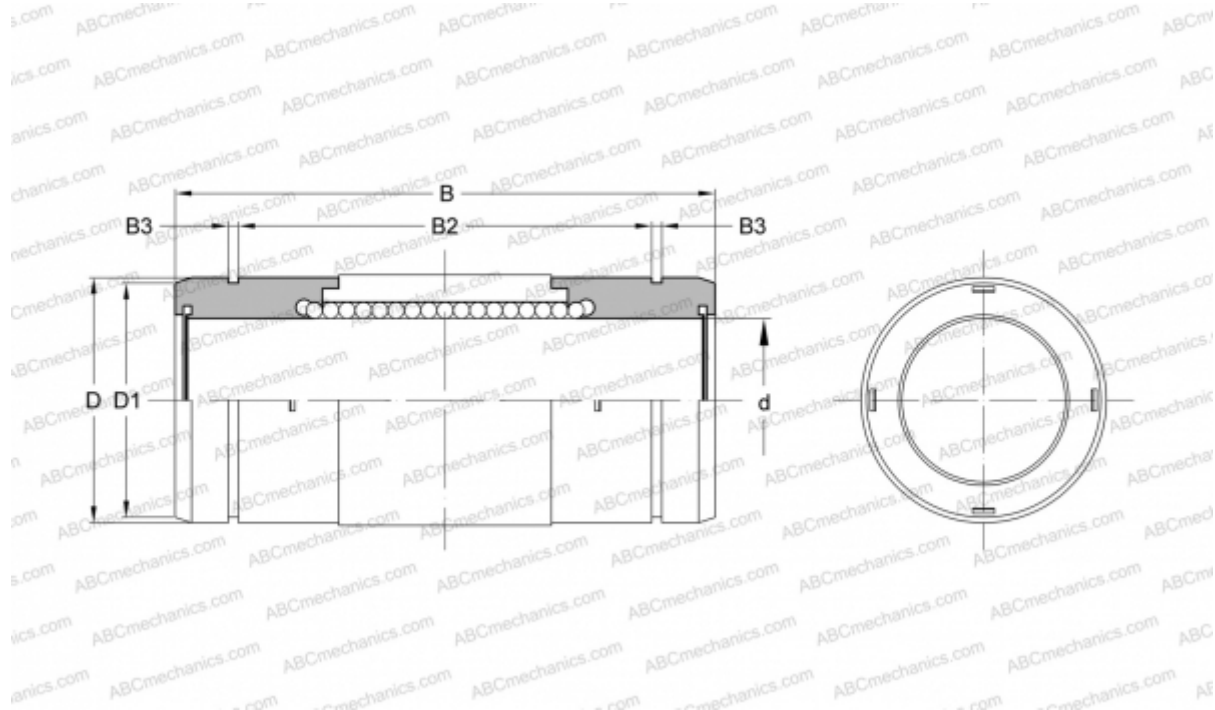

Technical specification

DIMENSIONS, MM

d	8,000
D	15,000
B	32,000
D1	14,300
B3	1,000

WEIGHT, KG 0,019

MANUFACTURER [NB](#)