

## SM16G-LUU NB

Linear bushing

TYPE: Shaft guidance systems, Linear bushing, Standard, Close type, Type SM..G-L, long (NB)

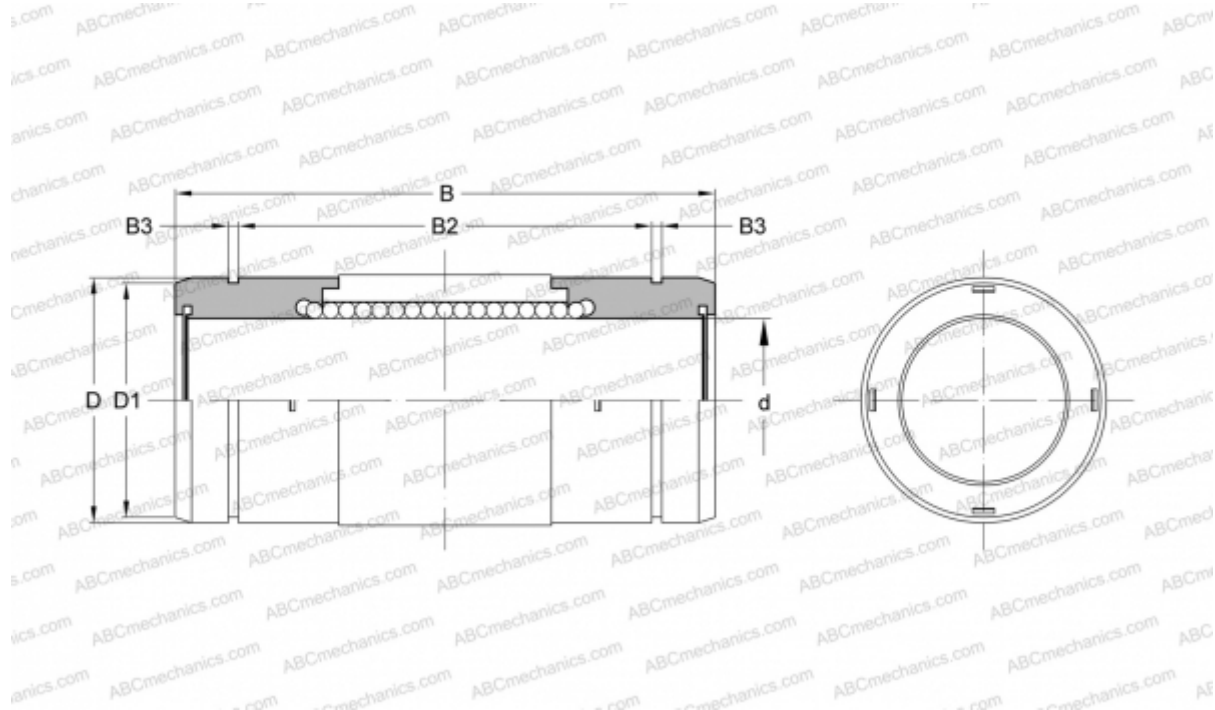

### Technical specification

#### DIMENSIONS, MM

d	16,000
D	28,000
B	53,000
D1	27,000
B3	1,000

**WEIGHT, KG** 0,099

**MANUFACTURER** [NB](#)