

## SM25G-LUU NB

Linear bushing

TYPE: Shaft guidance systems, Linear bushing, Standard, Close type, Type SM..G-L, long (NB)

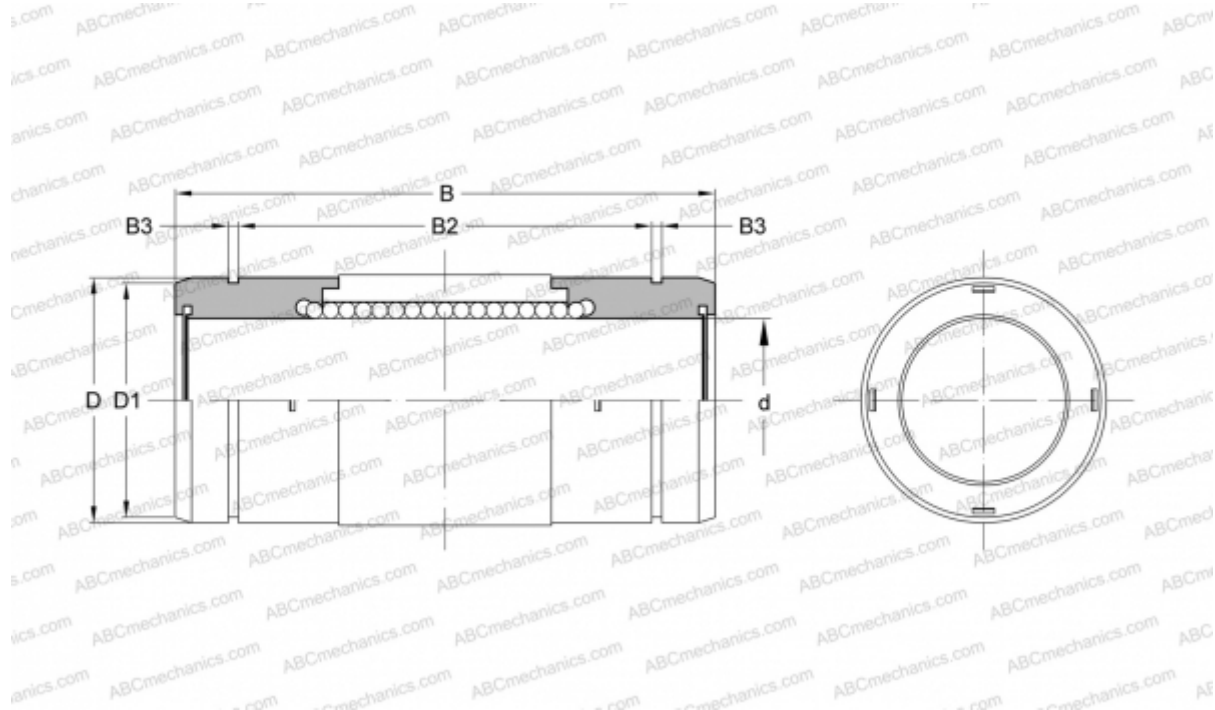

### Technical specification

#### DIMENSIONS, MM

d	25,000
D	40,000
B	83,000
D1	38,000
B3	1,000

**WEIGHT, KG** 0,315

**MANUFACTURER** [NB](#)