

SM30G-LUU NB

Linear bushing

TYPE: Shaft guidance systems, Linear bushing, Standard, Close type, Type SM..G-L, long (NB)

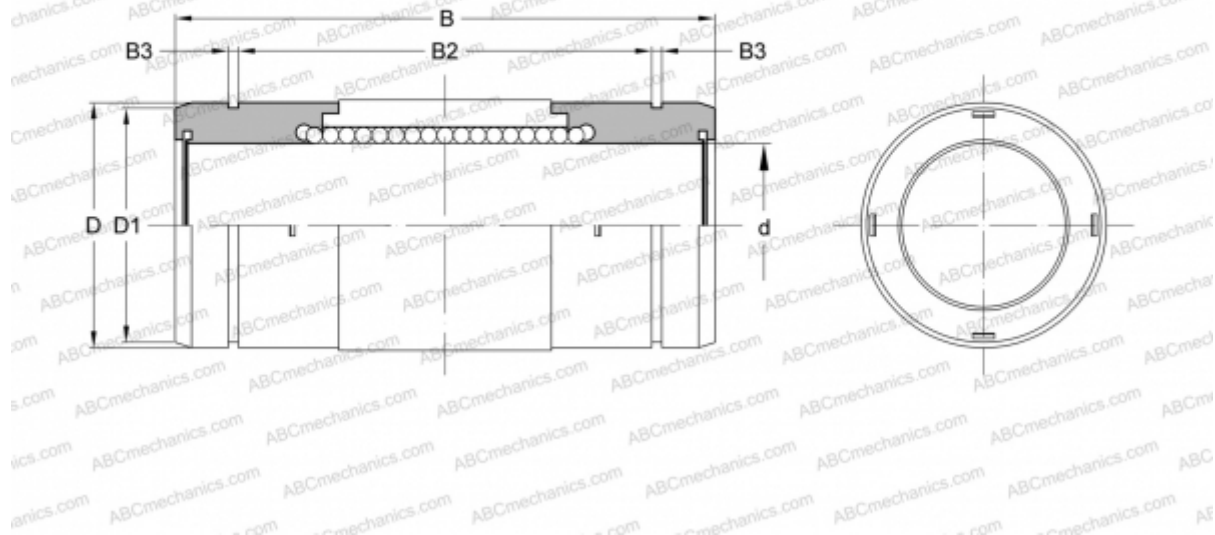

Technical specification

DIMENSIONS, MM

d	30,000
D	45,000
B	90,000
D1	43,000
B3	1,000

WEIGHT, KG 0,347

MANUFACTURER [NB](#)