

SMK 6G-LUU NB

Linear bushing

TYPE: Shaft guidance systems, Linear bushing, With flange, Square type, Type SMK..G-L (NB)

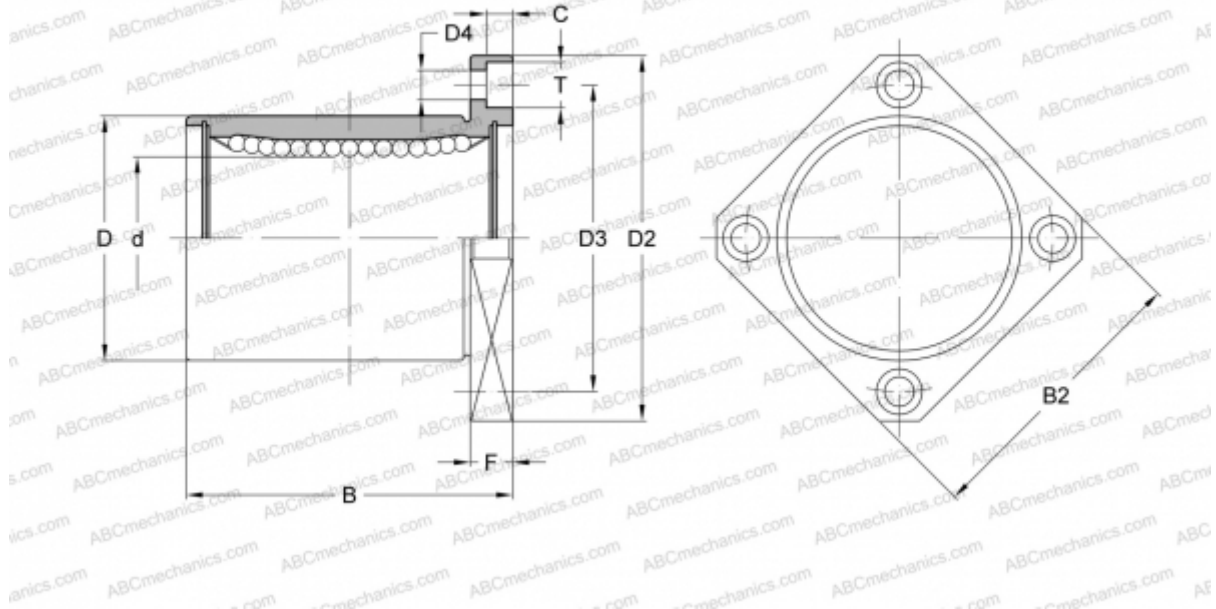

Technical specification

DIMENSIONS, MM

d	6,000
D	12,000
B	26,000
D2	28,000
D3	20,000
D4	3,500
B2	22,000
T	6,000
C	3,100
F	5

WEIGHT, KG 0,020

MANUFACTURER [NB](#)