

SMK 10G-LUU NB

Linear bushing

TYPE: Shaft guidance systems, Linear bushing, With flange, Square type, Type SMK..G-L (NB)

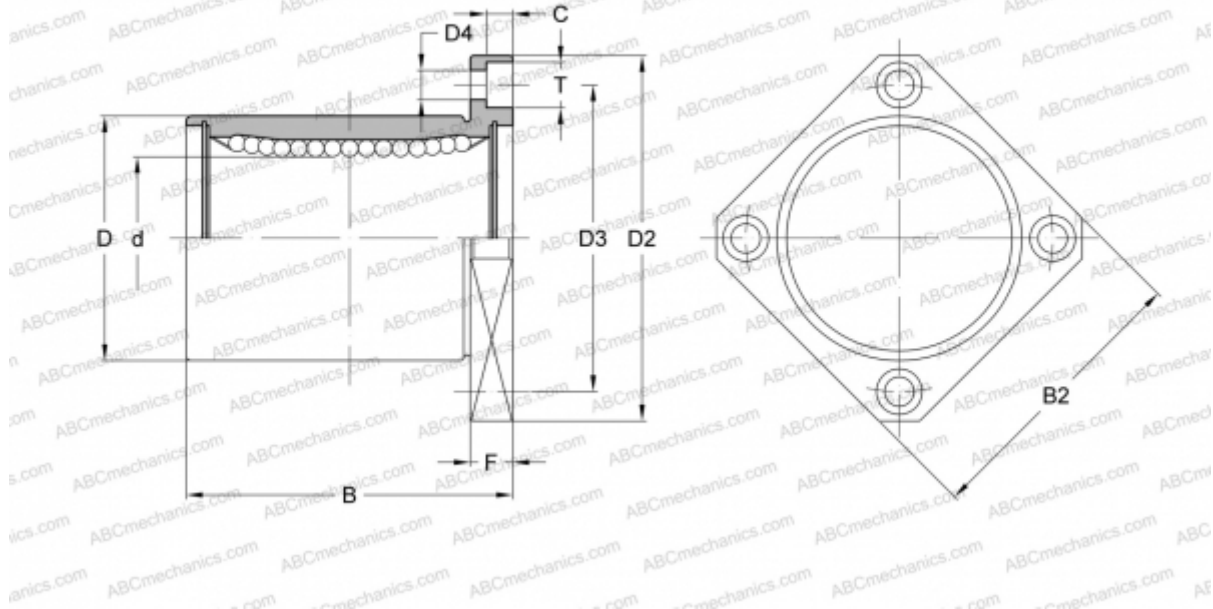

Technical specification

DIMENSIONS, MM

d	10,000
D	19,000
B	39,000
D2	40,000
D3	29,000
D4	4,500
B2	30,000
T	7,500
C	4,100
F	6

WEIGHT, KG 0,059

MANUFACTURER [NB](#)