

SMK 13G-LUU NB

Linear bushing

TYPE: Shaft guidance systems, Linear bushing, With flange, Square type, Type SMK..G-L (NB)

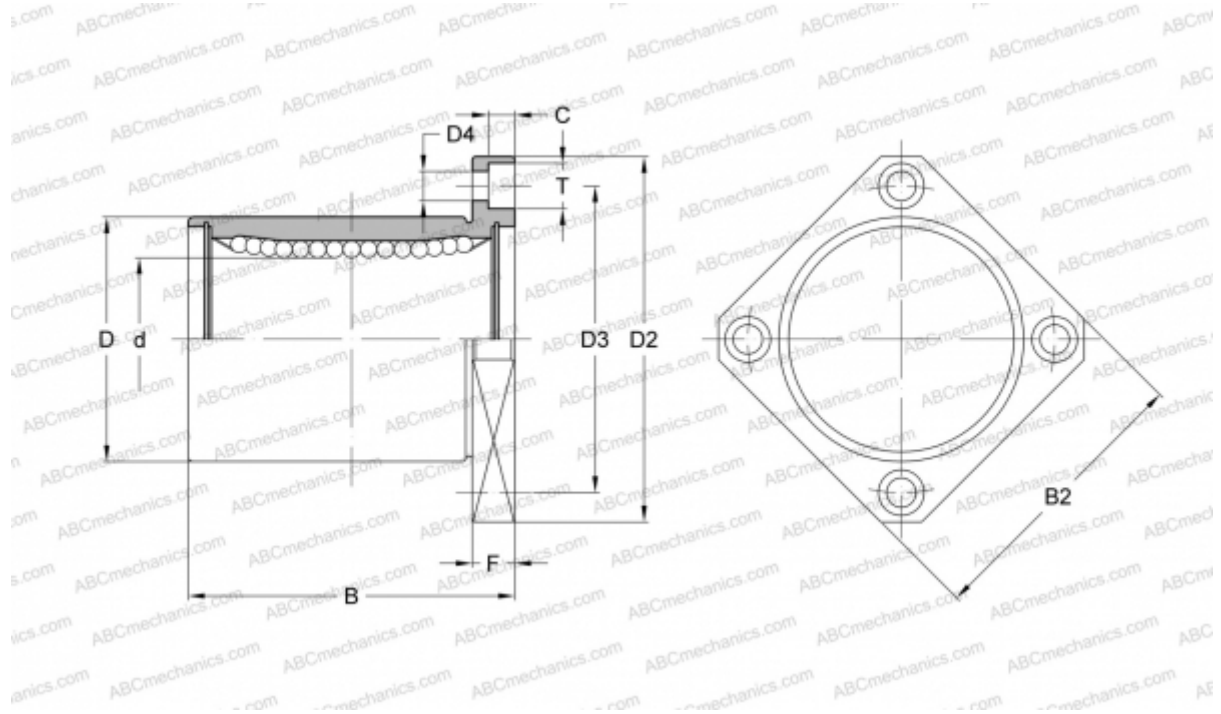

Technical specification

DIMENSIONS, MM

d	13,000
D	23,000
B	45,000
D2	43,000
D3	33,000
D4	4,500
B2	34,000
T	7,500
C	4,100
F	6

WEIGHT, KG 0,088

MANUFACTURER [NB](#)