

SMK 16G-LUU NB

Linear bushing

TYPE: Shaft guidance systems, Linear bushing, With flange, Square type, Type SMK..G-L (NB)

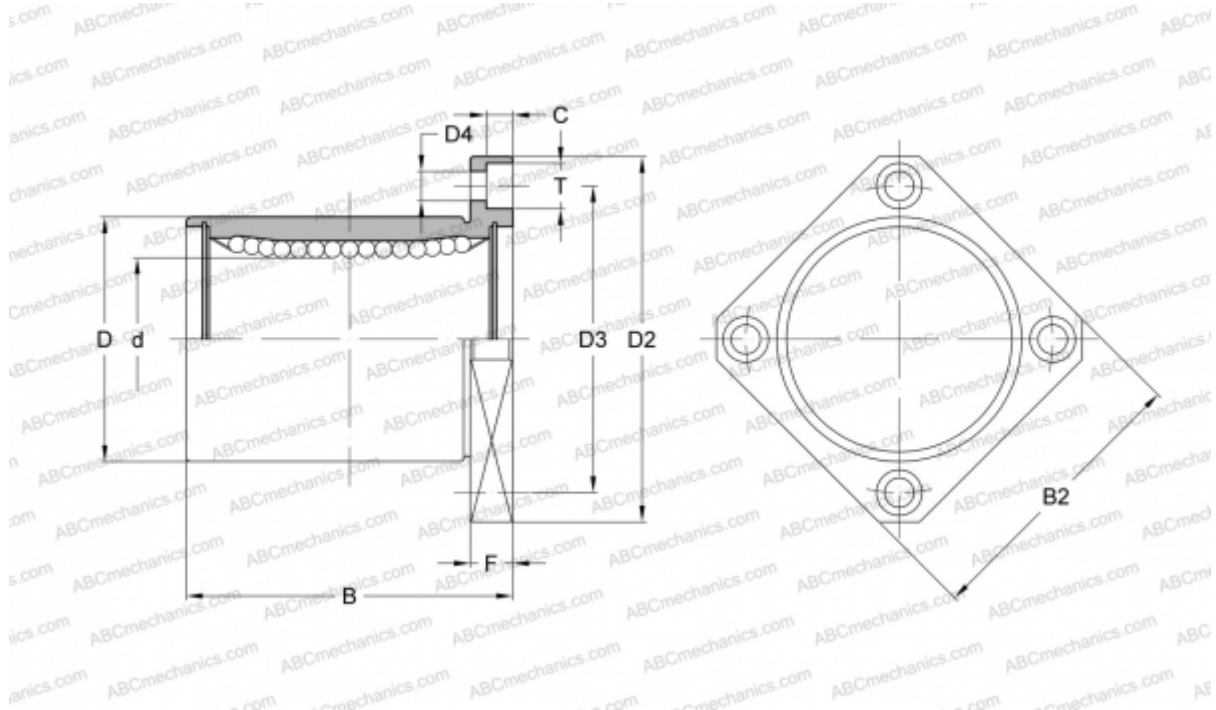

Technical specification

DIMENSIONS, MM

d	16,000
D	28,000
B	53,000
D2	48,000
D3	38,000
D4	4,500
B2	37,000
T	7,500
C	4,100
F	6

WEIGHT, KG 0,125

MANUFACTURER [NB](#)