

KBT 8UU NB

Linear bushing

TYPE: Shaft guidance systems, Linear bushing, With flange, Oval type, Type KBT, European standard, Steel cage (NB)

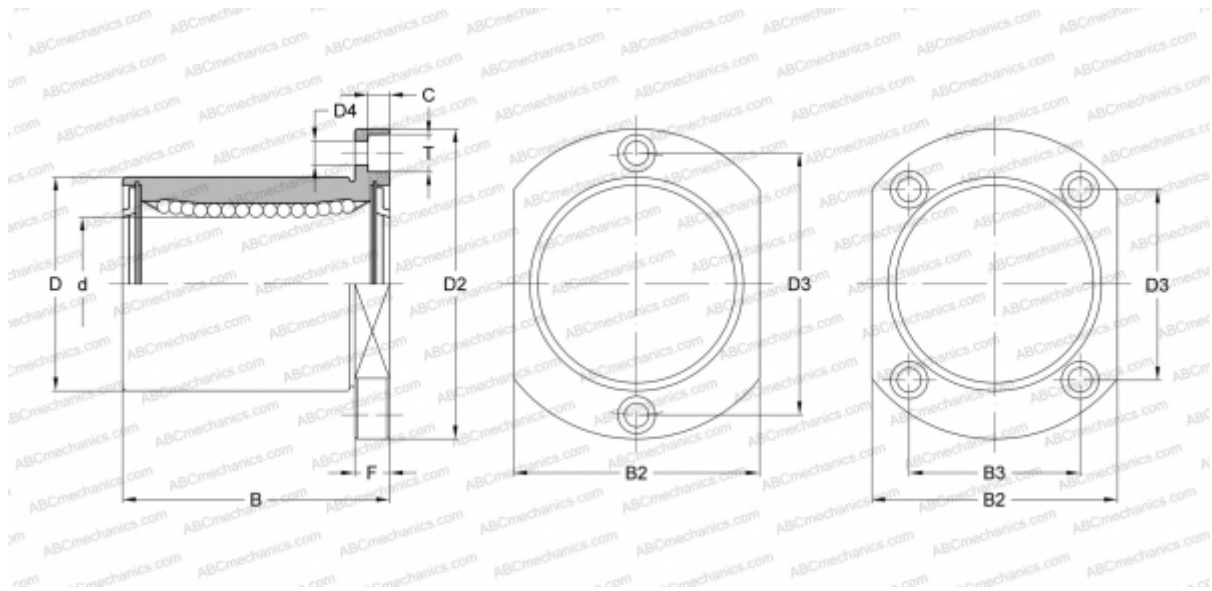

Technical specification

DIMENSIONS, MM

d	8,000
D	16,000
B	25,000
D2	32,000
D3	24,000
D4	3,500
B2	22,000
T	6,000
C	3,100
F	5

WEIGHT, KG 0,037

MANUFACTURER [NB](#)