

KBST25GUU NB

Linear bushing

TYPE: Shaft guidance systems, Linear bushing, With flange, Oval type, Type KBT, European standard, Corrosion resistance, Plastic cage (NB)

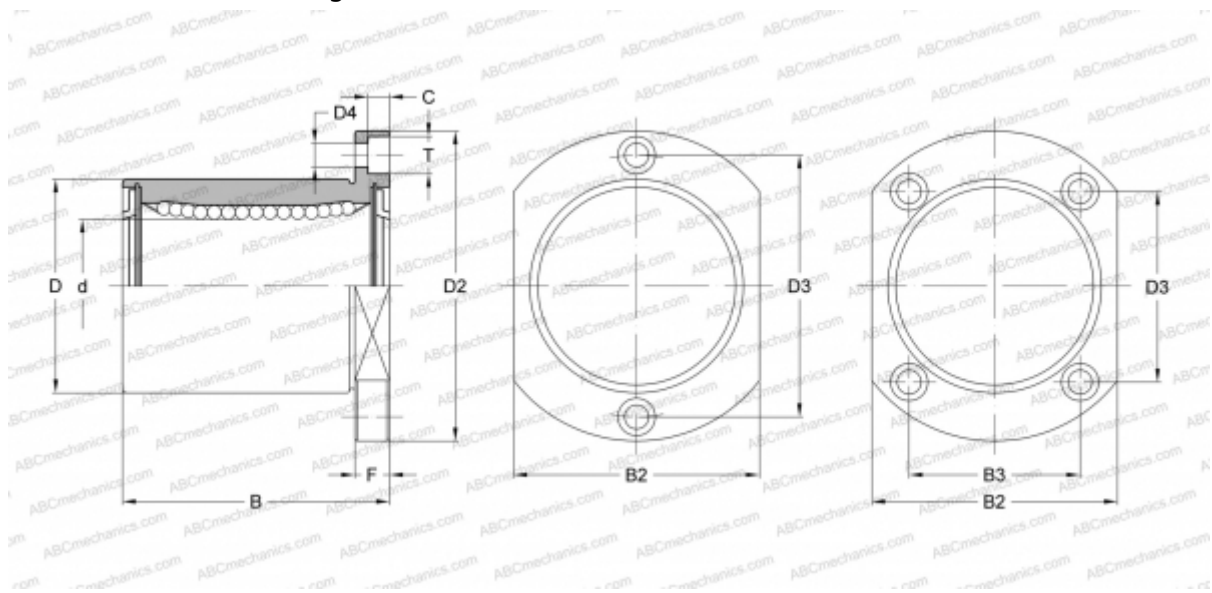

Technical specification

DIMENSIONS, MM

d	25,000
D	40,000
B	58,000
D2	62,000
D3	40,000
D4	5,500
B2	46,000
B3	32,000
T	9,000
C	5,100
F	8

WEIGHT, KG 0,297

MANUFACTURER [NB](#)