

SWST12UU NB

Linear bushing

TYPE: Shaft guidance systems, Linear bushing, With flange, Oval type, Type SWT, American standard, Corrosion resistance, Stainless steel cage (NB)

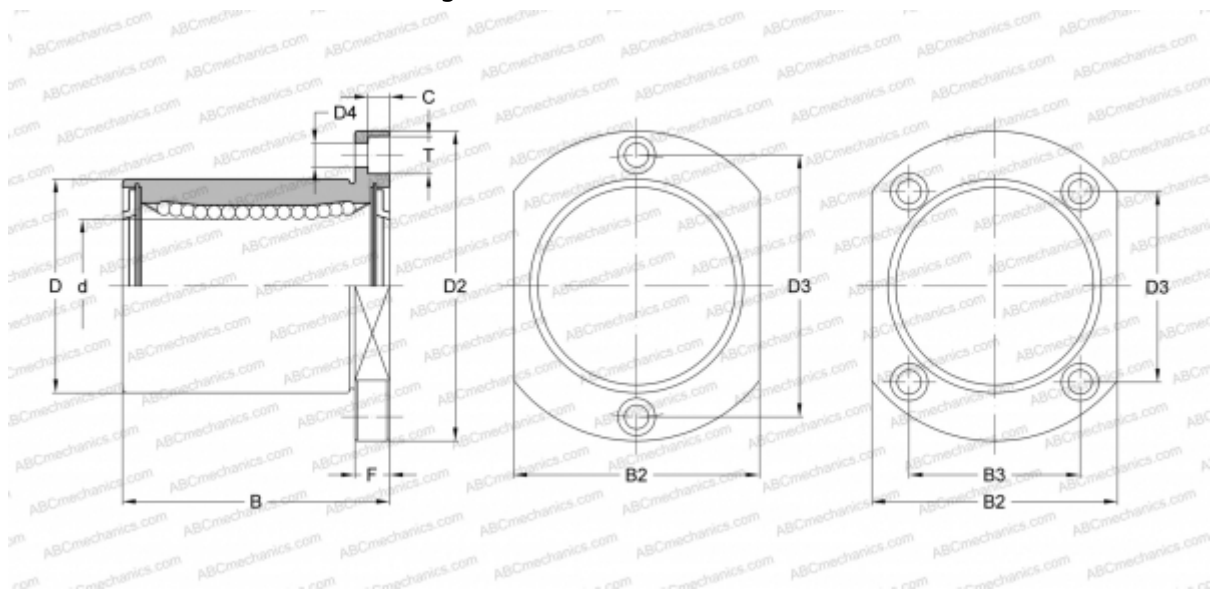

Technical specification

DIMENSIONS, MM

d	19,050
D	31,750
B	41,275
D2	55,563
D3	38,100
D4	5,555
B2	38,100
B3	25,400
T	8,738
C	5,156
F	38.1

WEIGHT, KG 0,162

MANUFACTURER [NB](#)