

AK 6GUU NB

Linear bushing, case unit

TYPE: Shaft guidance systems, Linear bushing, case unit, Close type, Block type, Type AK, compact (NB)

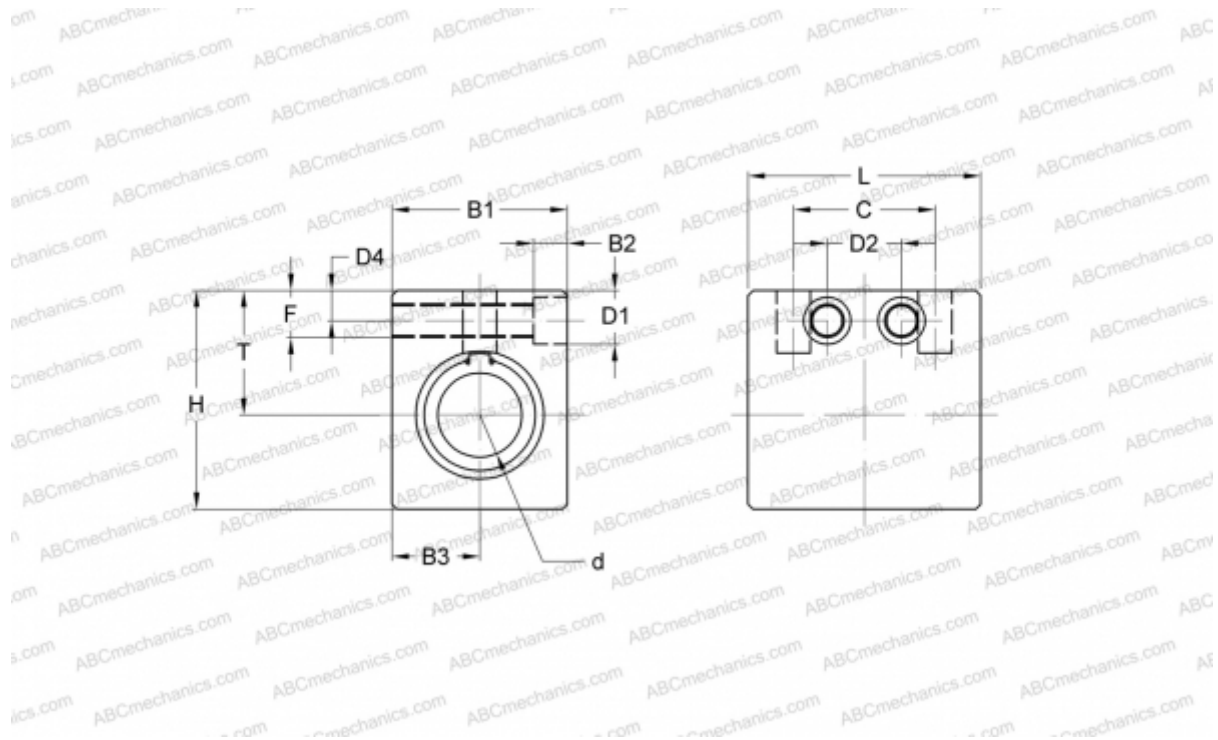

Technical specification

DIMENSIONS, MM

B1	16,000
H	22,000
L	27,000
d	6,000
D1	6,000
D2	9,000
D4	5,000
B2	5,000
B3	8,000
T	14,000
C	18,000
F	8

WEIGHT, KG 0,022

MANUFACTURER [NB](#)