

AK 8GUU NB

Linear bushing, case unit

TYPE: Shaft guidance systems, Linear bushing, case unit, Close type, Block type, Type AK, compact (NB)

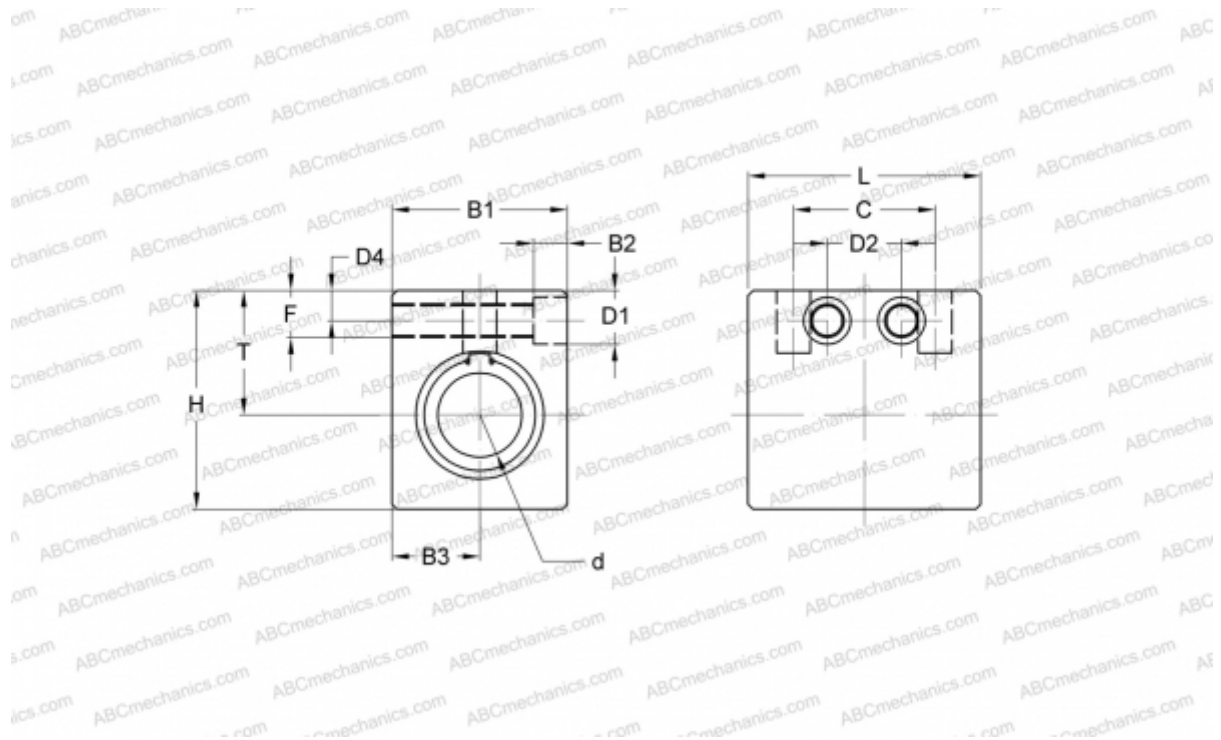

Technical specification

DIMENSIONS, MM

B1	20,000
H	26,000
L	32,000
d	8,000
D1	6,000
D2	10,000
D4	5,000
B2	5,000
B3	10,000
T	16,000
C	20,000
F	8.5

WEIGHT, KG 0,040

MANUFACTURER [NB](#)