

AK 10GUU NB

Linear bushing, case unit

TYPE: Shaft guidance systems, Linear bushing, case unit, Close type, Block type, Type AK, compact (NB)

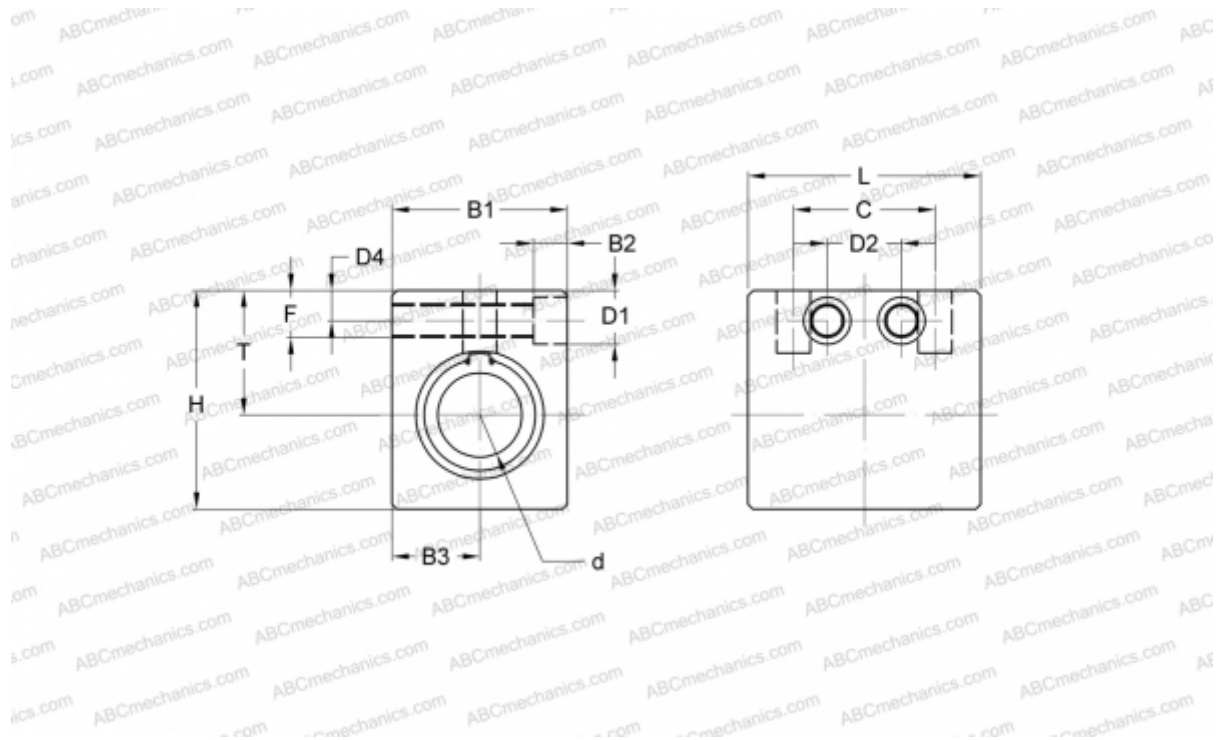

Technical specification

DIMENSIONS, MM

B1	26,000
H	32,000
L	39,000
d	10,000
D1	8,000
D2	15,000
D4	6,000
B2	6,000
B3	13,000
T	19,000
C	27,000
F	9.5

WEIGHT, KG 0,080

MANUFACTURER [NB](#)