

SMT 16GUU-E NB

Linear bushing

TYPE: Shaft guidance systems, Linear bushing, Pilot flange location, Oval type, Type SMT..E, Asian standard, Plastic cage (NB)

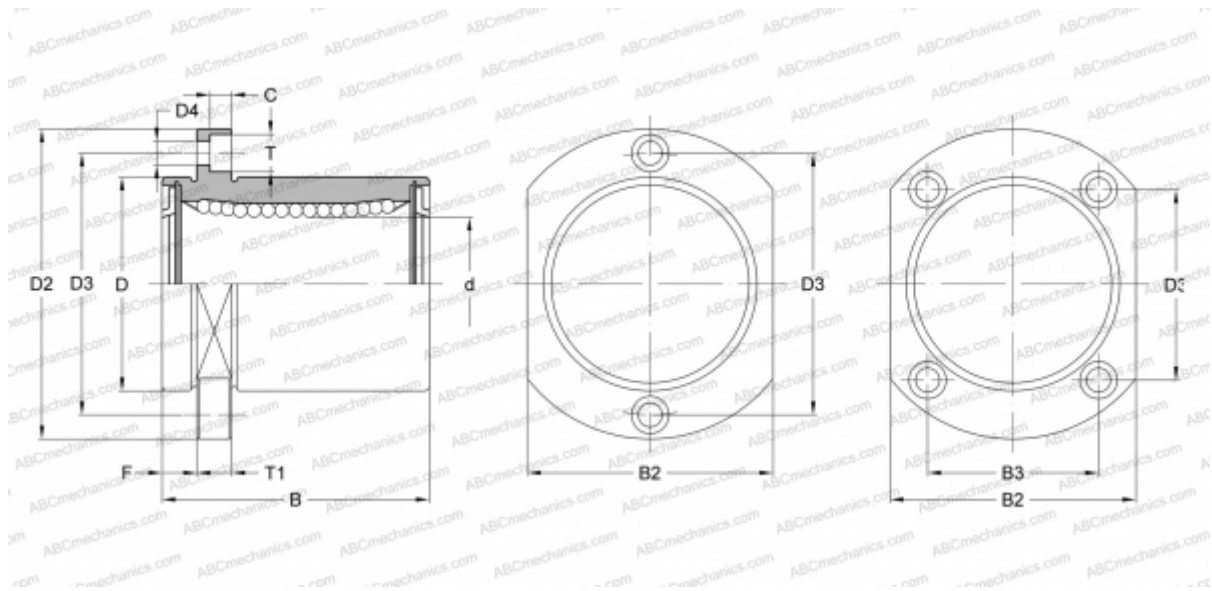

Technical specification

DIMENSIONS, MM

d	16,000
D	28,000
B	37,000
D2	48,000
D3	31,000
D4	4,500
B2	34,000
B3	22,000
T	7,500
T1	6,000
F	6

WEIGHT, KG 0,112

MANUFACTURER [NB](#)