

SMST 13UU-E NB

Linear bushing

TYPE: Shaft guidance systems, Linear bushing, Pilot flange location, Oval type, Type SMT..E, Asian standard, Corrosion resistance, Stainless steel cage (NB)

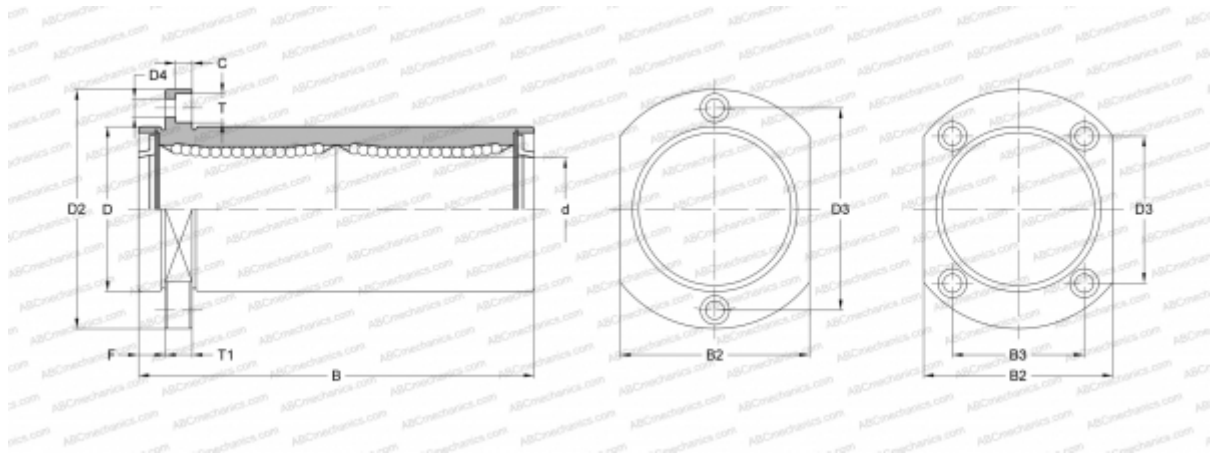

Technical specification

DIMENSIONS, MM

d	13,000
D	23,000
B	32,000
D2	43,000
D3	33,000
D4	4,500
B2	29,000
T	7,500
T1	6,000
F	6

WEIGHT, KG 0,081

MANUFACTURER [NB](#)