

## SWFC32 NB

Linear bushing

TYPE: Shaft guidance systems, Linear bushing, Middle flange location, Circular type, Type SWFC, American standard, Steel cage (NB)

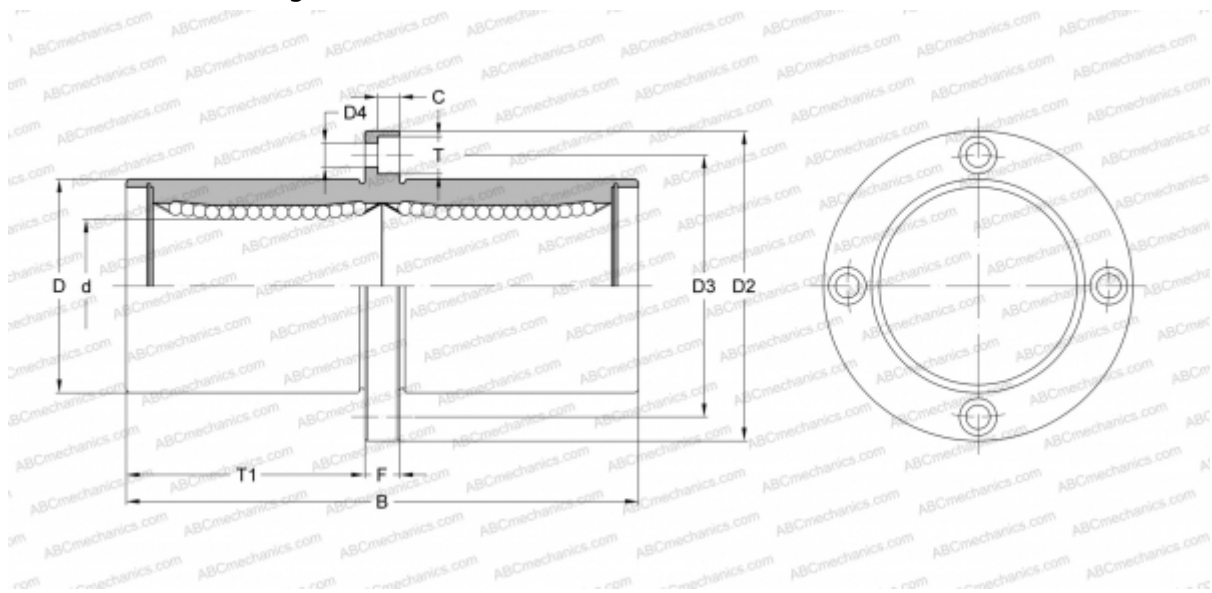

### Technical specification

#### DIMENSIONS, MM

d	50,800
D	76,200
B	196,850
D2	111,125
D3	93,662
D4	8,731
T	12,700
T1	92,075
C	8,334
F	12.7

**WEIGHT, KG** 2,800

**MANUFACTURER** [NB](#)