

SWKC 6 NB

Linear bushing

TYPE: Shaft guidance systems, Linear bushing, Middle flange location, Square type, Type SWKC, American standard, Steel cage (NB)

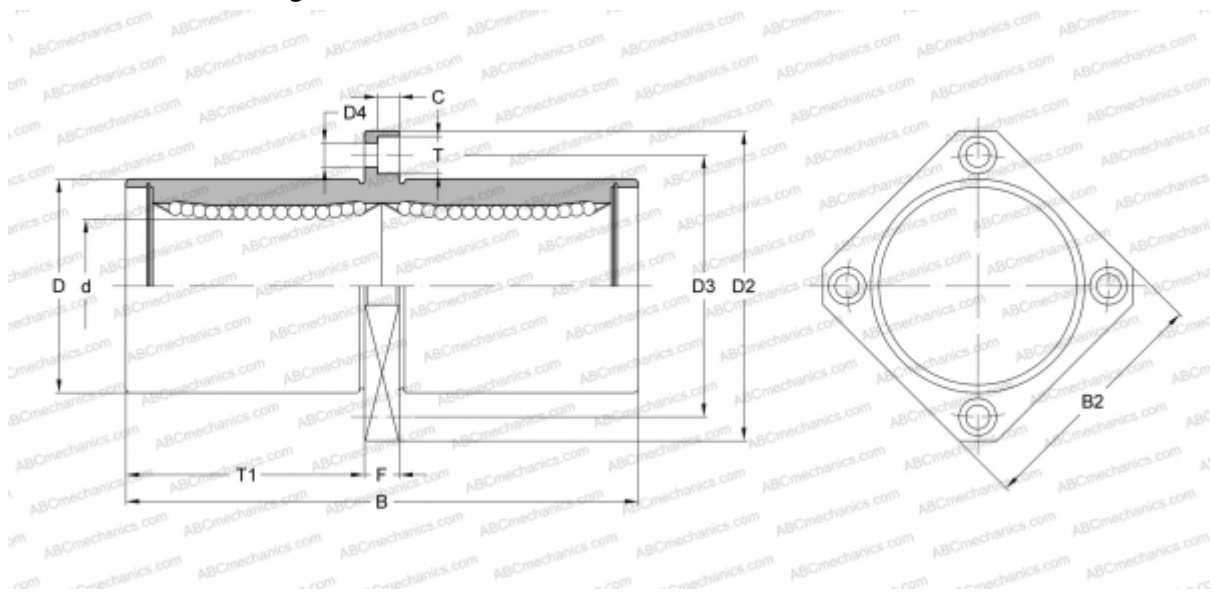

Technical specification

DIMENSIONS, MM

d	9,525
D	15,875
B	40,481
D2	38,100
D3	26,988
D4	4,763
B2	31,750
T	7,541
T1	17,066
C	4,366
F	6.35

WEIGHT, KG 0,045

MANUFACTURER [NB](#)