

SWKC 4G NB

Linear bushing

TYPE: Shaft guidance systems, Linear bushing, Middle flange location, Square type, Type SWKC, American standard, Plastic cage (NB)

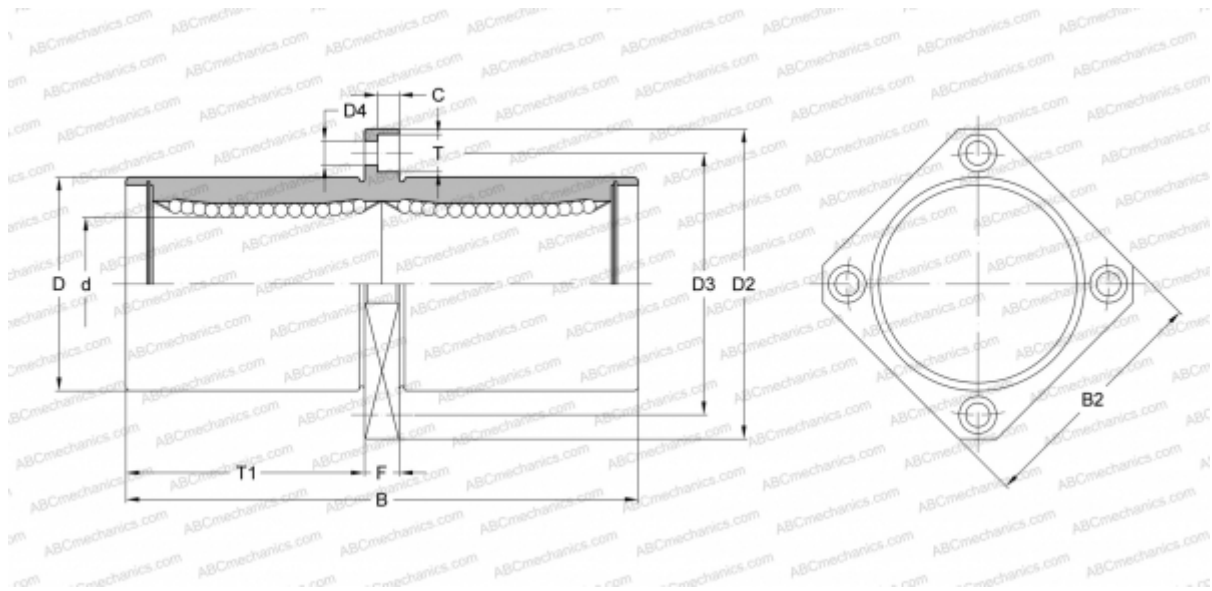

Technical specification

DIMENSIONS, MM

d	6,350
D	12,700
B	34,925
D2	31,750
D3	22,225
D4	3,969
B2	25,400
T	6,350
T1	14,684
C	3,572
F	5.556

WEIGHT, KG 0,033

MANUFACTURER [NB](#)