

SWKC10G NB

Linear bushing

TYPE: Shaft guidance systems, Linear bushing, Middle flange location, Square type, Type SWKC, American standard, Plastic cage (NB)

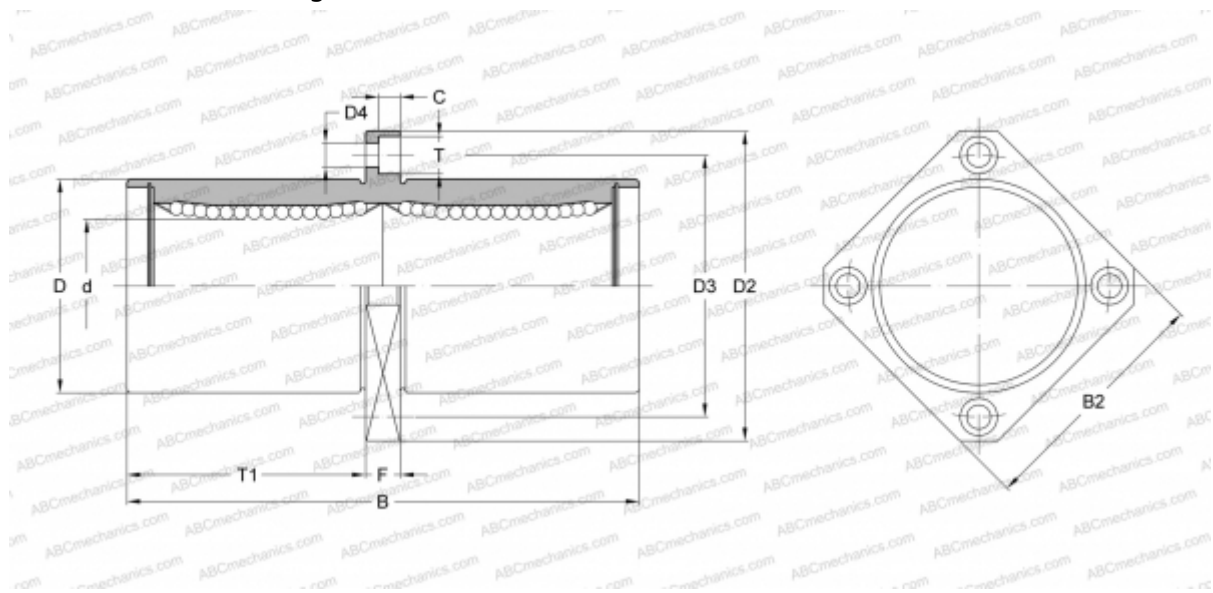

Technical specification

DIMENSIONS, MM

d	15,875
D	28,575
B	71,438
D2	50,800
D3	39,688
D4	4,763
B2	38,100
T	7,541
T1	32,544
C	4,366
F	6.35

WEIGHT, KG 0,200

MANUFACTURER [NB](#)