

SWSKC16 NB

Linear bushing

TYPE: Shaft guidance systems, Linear bushing, Middle flange location, Square type, Type SWKC, American standard, Corrosion resistance, Stainless steel cage (NB)

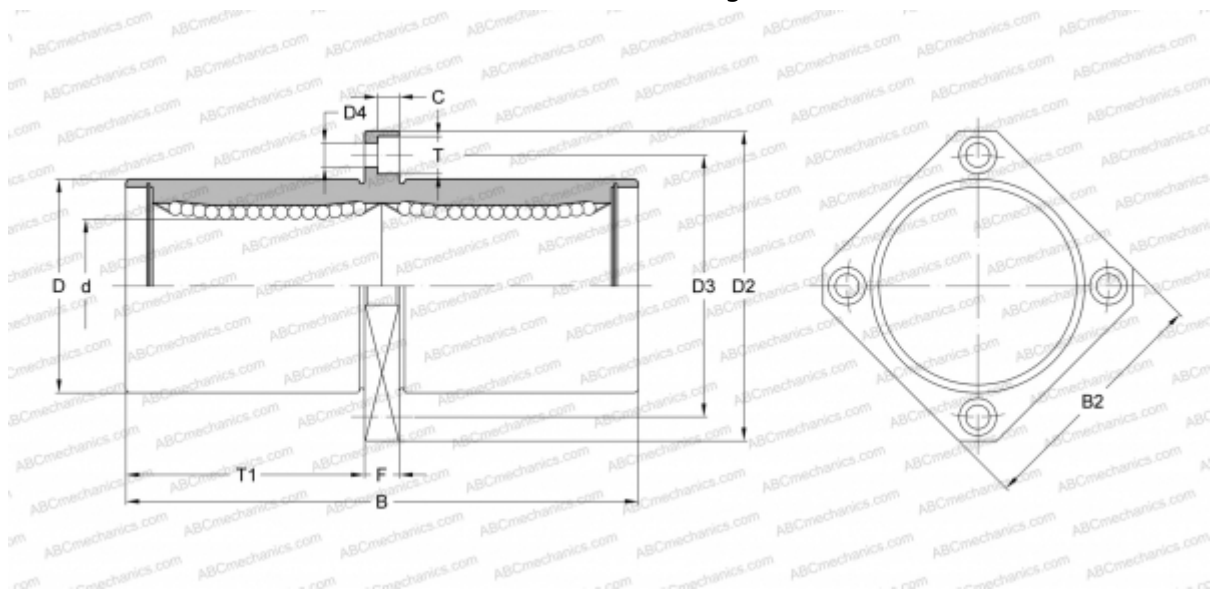

Technical specification

DIMENSIONS, MM

d	25,400
D	39,688
B	108,744
D2	63,500
D3	51,594
D4	5,556
B2	50,800
T	8,731
T1	50,403
C	5,159
F	7.938

WEIGHT, KG 0,470

MANUFACTURER [NB](#)