

SWSKC12G NB

Linear bushing

TYPE: Shaft guidance systems, Linear bushing, Middle flange location, Square type, Type SWKC, American standard, Corrosion resistance, Plastic cage (NB)

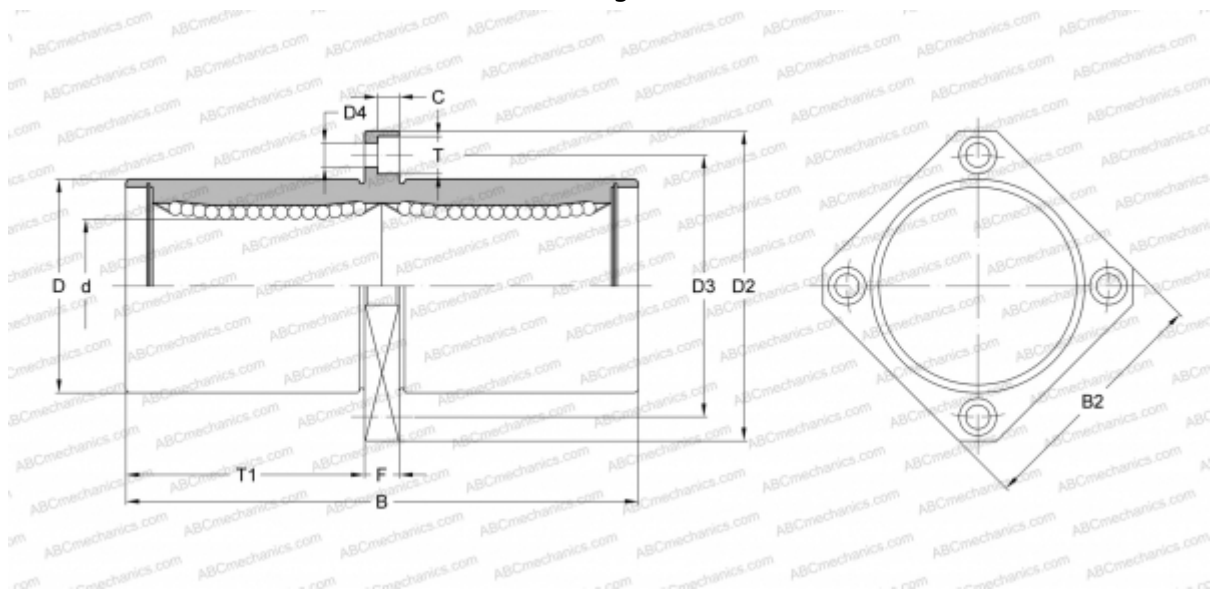

Technical specification

DIMENSIONS, MM

d	19,050
D	31,750
B	78,581
D2	55,563
D3	43,656
D4	5,556
B2	42,863
T	8,731
T1	35,322
C	5,159
F	7.938

WEIGHT, KG 0,240

MANUFACTURER [NB](#)