

CE30 NB

Linear bushing, case unit

TYPE: Shaft guidance systems, Linear bushing, case unit, Open type, Block type, Type CE, Standart (NB)

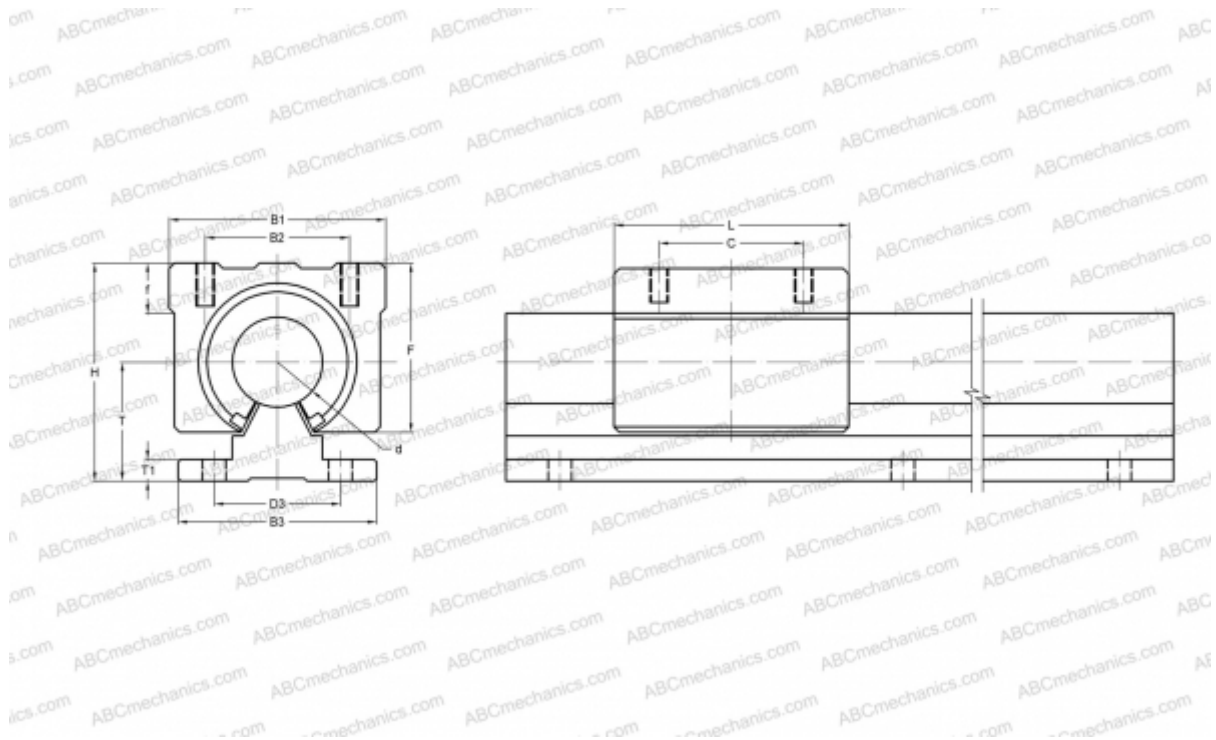

Technical specification

DIMENSIONS, MM

B1	70,000
H	70,000
L	70,000
d	30,000
D3	40,000
B2	50,000
B3	60,000
T	37,000
T1	7,000
f	15,000
C	50,000
F	56

WEIGHT, KG 0,630

MANUFACTURER [NB](#)