

CD16 NB

Linear bushing, case unit

TYPE: Shaft guidance systems, Linear bushing, case unit, Open type, Clearance adjustable type, Type CD, Standart (NB)

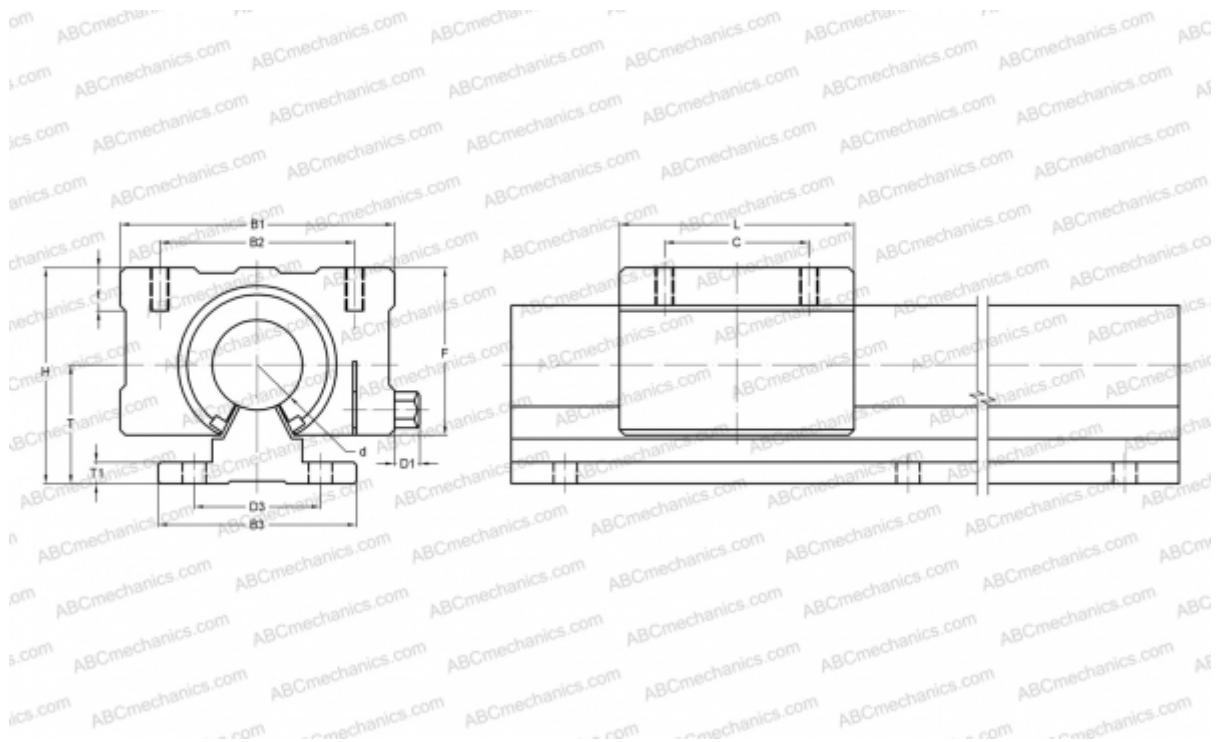

Technical specification

DIMENSIONS, MM

B1	50,000
H	45,000
L	45,000
d	16,000
D1	6,000
D3	30,000
B2	36,000
B3	40,000
T	25,000
T1	5,000
f	9,000
C	30,000
F	33

WEIGHT, KG 0,170

MANUFACTURER [NB](#)