

CDS25 NB

Linear bushing, case unit

TYPE: Shaft guidance systems, Linear bushing, case unit, Open type, Clearance adjustable type, Type CD, Corrosion resistance (NB)

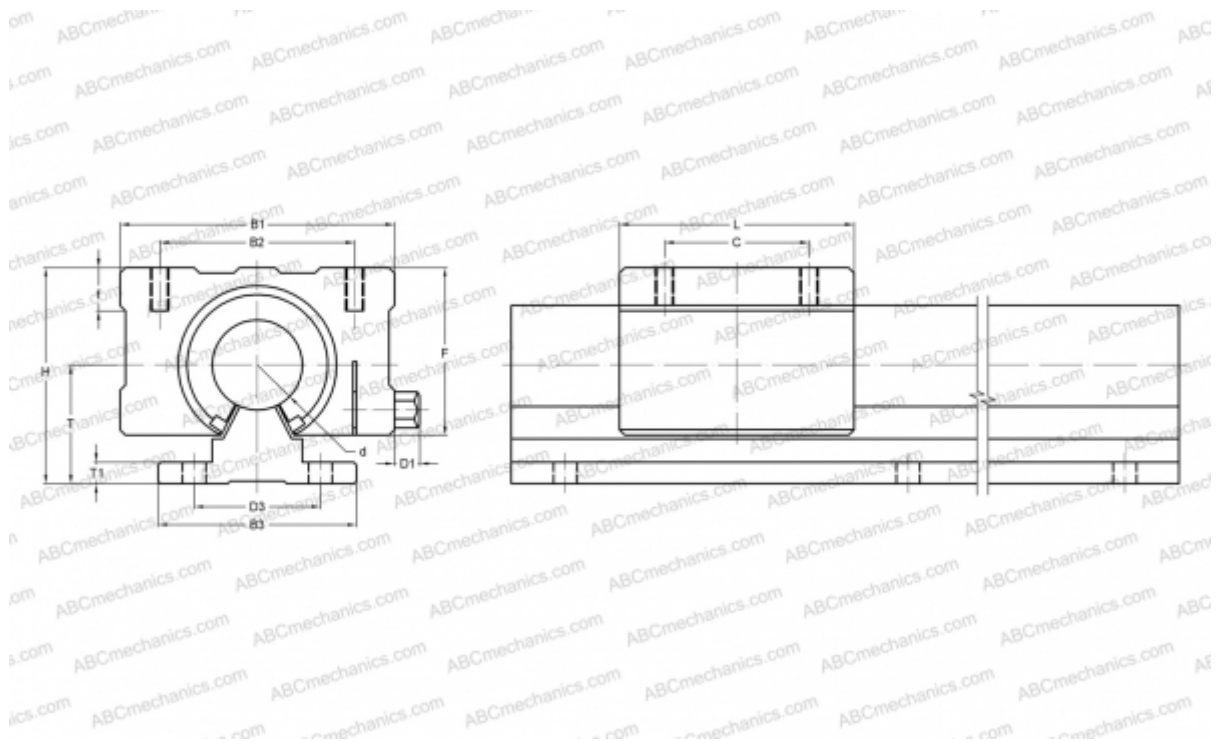

Technical specification

DIMENSIONS, MM

B1	76,000
H	60,000
L	65,000
d	25,000
D1	7,000
D3	35,000
B2	54,000
B3	55,000
T	33,000
T1	6,000
f	14,000
C	40,000
F	47

WEIGHT, KG 0,580

MANUFACTURER [NB](#)