

## KN16-B-PP INA

Linear bushing

TYPE: Shaft guidance systems, Linear bushing, Self aligning, Close type, Type KN..B-PP, light range, sealed on both sides (INA)

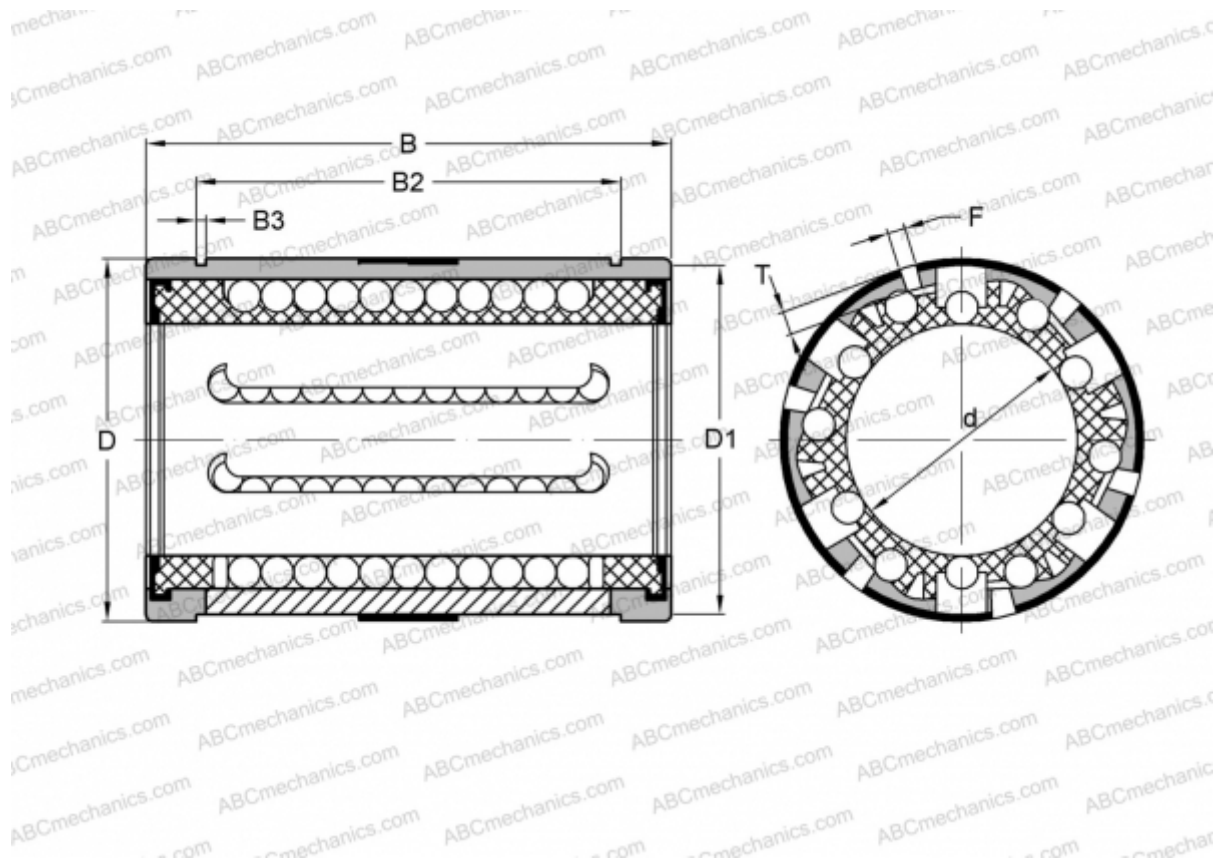

### Technical specification

#### DIMENSIONS, MM

d	16,000
D	26,000
B	36,000
D1	25,000
B2	24,600
B3	1,300
T	0,700
F	3

**WEIGHT, KG** 0,030

**MANUFACTURER** [INA](#)