

KN20-B-PP INA

Linear bushing

TYPE: Shaft guidance systems, Linear bushing, Self aligning, Close type, Type KN..B-PP, light range, sealed on both sides (INA)

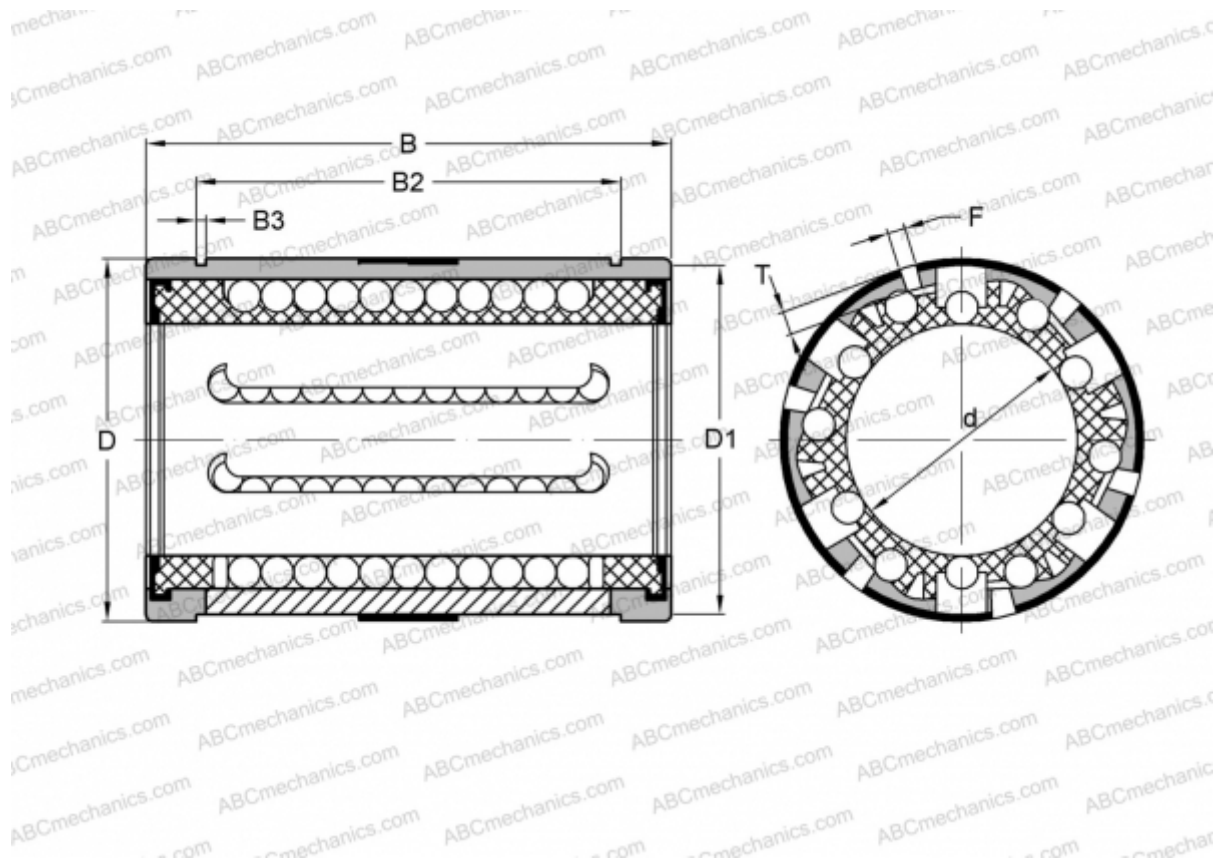

Technical specification

DIMENSIONS, MM

d	20,000
D	32,000
B	45,000
D1	30,700
B2	31,200
B3	1,600
T	0,900
F	3

WEIGHT, KG 0,060

MANUFACTURER [INA](#)