

## KN25-B-PP INA

Linear bushing

TYPE: Shaft guidance systems, Linear bushing, Self aligning, Close type, Type KN..B-PP, light range, sealed on both sides (INA)

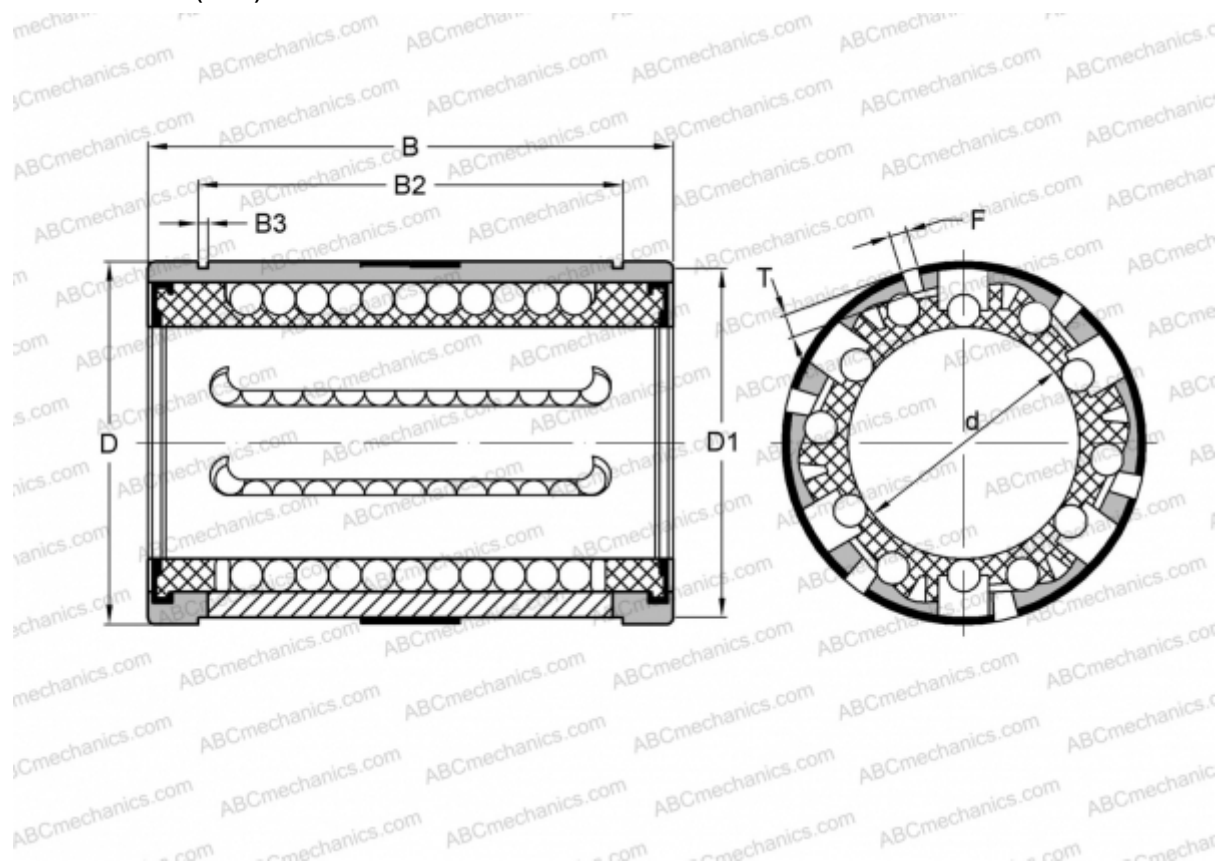

### Technical specification

#### DIMENSIONS, MM

d	25,000
D	40,000
B	58,000
D1	38,500
B2	43,700
B3	1,850
T	1,400
F	3

**WEIGHT, KG** 0,130

**MANUFACTURER** [INA](#)