

KN30-B-PP INA

Linear bushing

TYPE: Shaft guidance systems, Linear bushing, Self aligning, Close type, Type KN..B-PP, light range, sealed on both sides (INA)

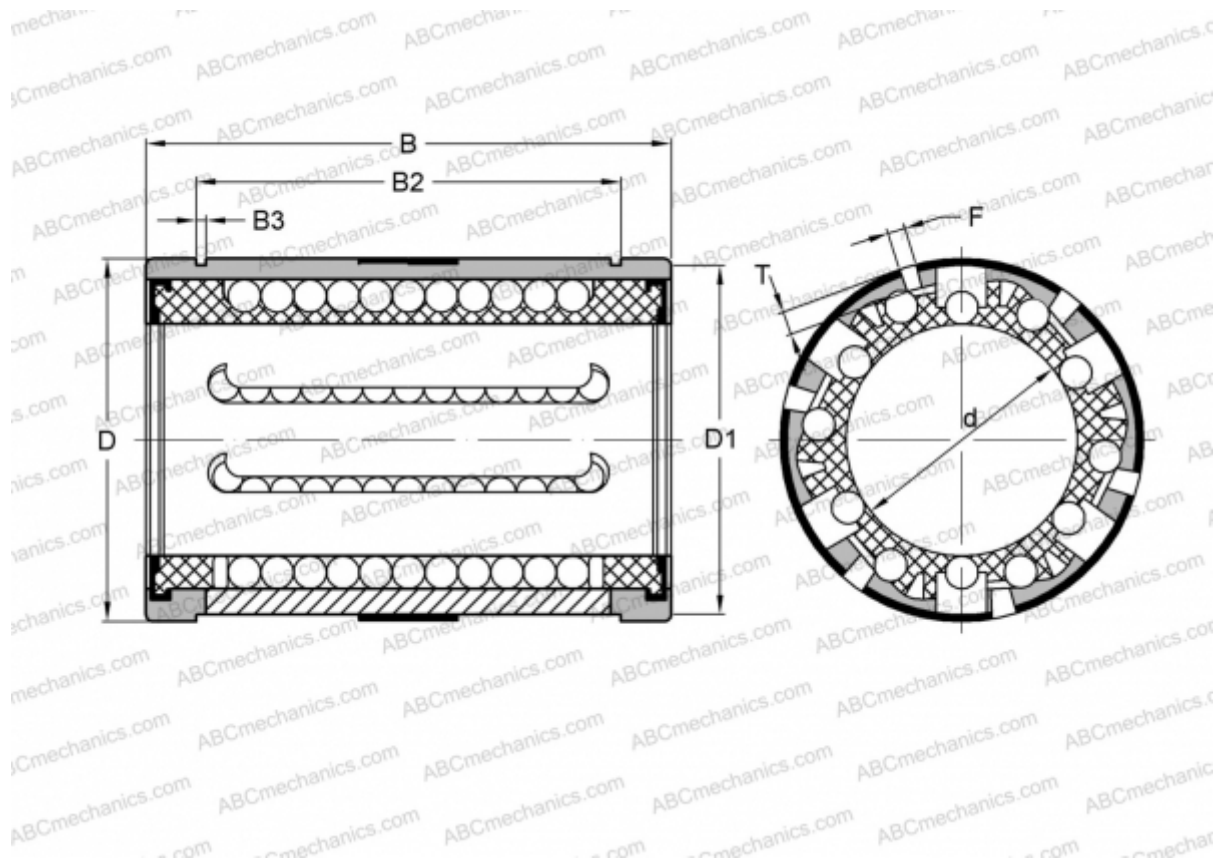

Technical specification

DIMENSIONS, MM

d	30,000
D	47,000
B	68,000
D1	44,700
B2	51,700
B3	1,850
T	2,200
F	3

WEIGHT, KG 0,190

MANUFACTURER [INA](#)