

KS25-PP INA

Linear bushing

TYPE: Shaft guidance systems, Linear bushing, Self aligning, Close type, Type KS..PP, heavy duty range, sealed on both sides (INA)

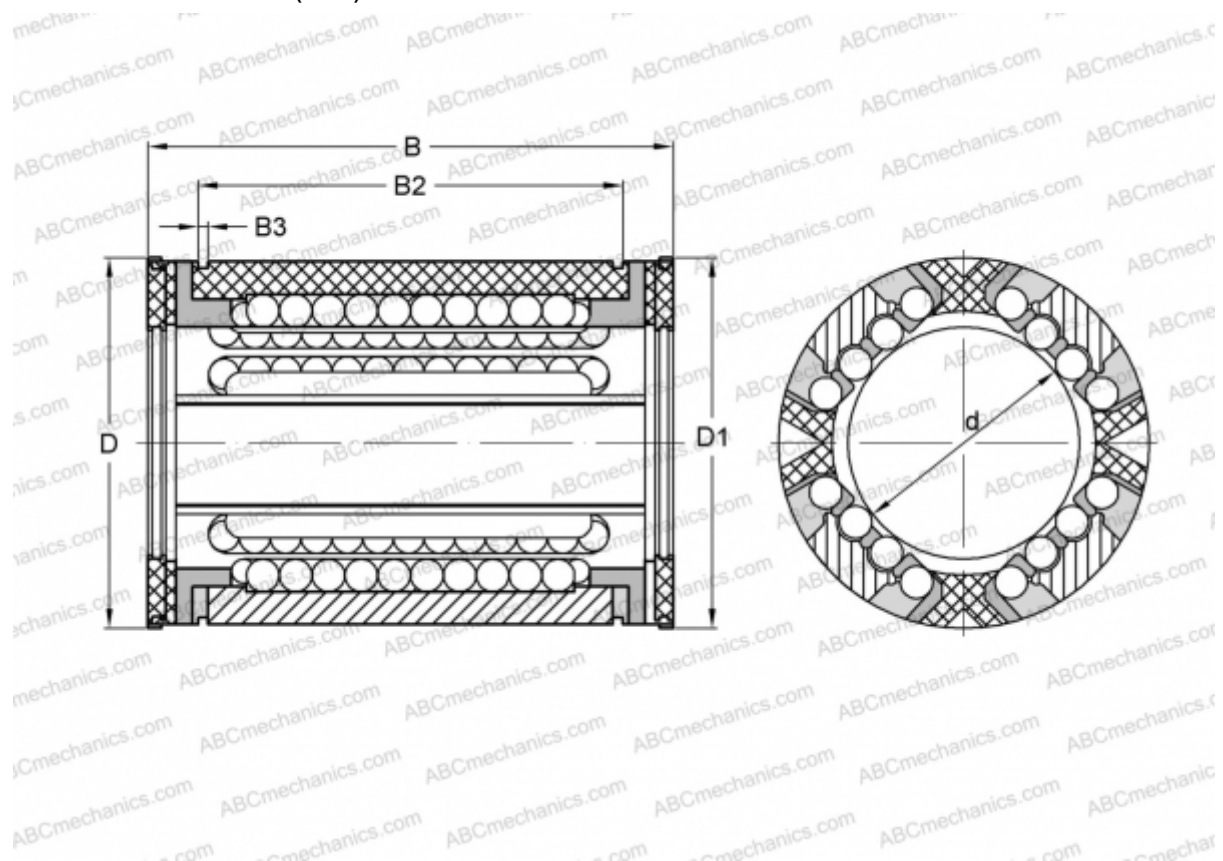

Technical specification

DIMENSIONS, MM

d	25,000
D	40,000
B	58,000
D1	38,000
B2	43,700
B3	1,850

WEIGHT, KG 0,102

MANUFACTURER [INA](#)