

## KS30-PP INA

Linear bushing

TYPE: Shaft guidance systems, Linear bushing, Self aligning, Close type, Type KS..PP, heavy duty range, sealed on both sides (INA)

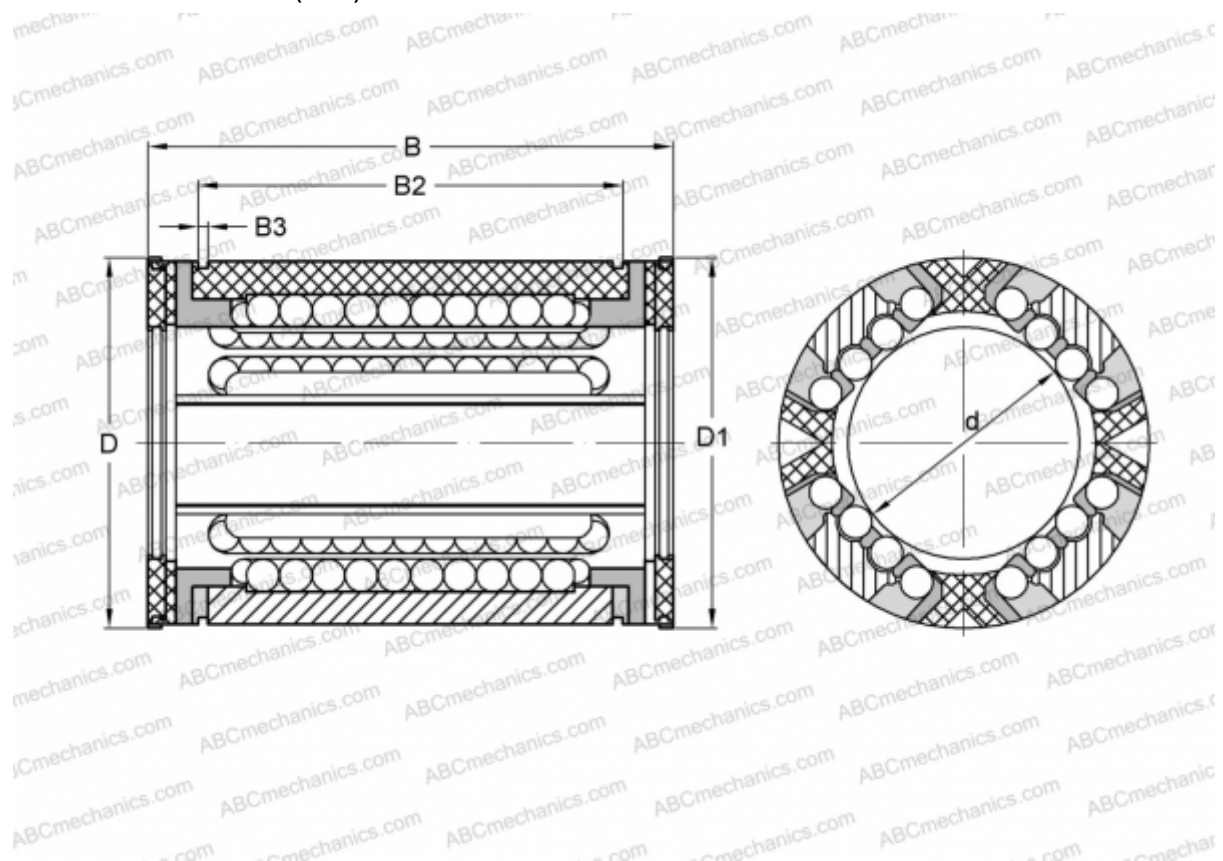

### Technical specification

#### DIMENSIONS, MM

d	30,000
D	47,000
B	68,000
D1	44,700
B2	51,700
B3	1,850

**WEIGHT, KG** 0,172

**MANUFACTURER** [INA](#)