

KS40-PP INA

Linear bushing

TYPE: Shaft guidance systems, Linear bushing, Self aligning, Close type, Type KS..PP, heavy duty range, sealed on both sides (INA)

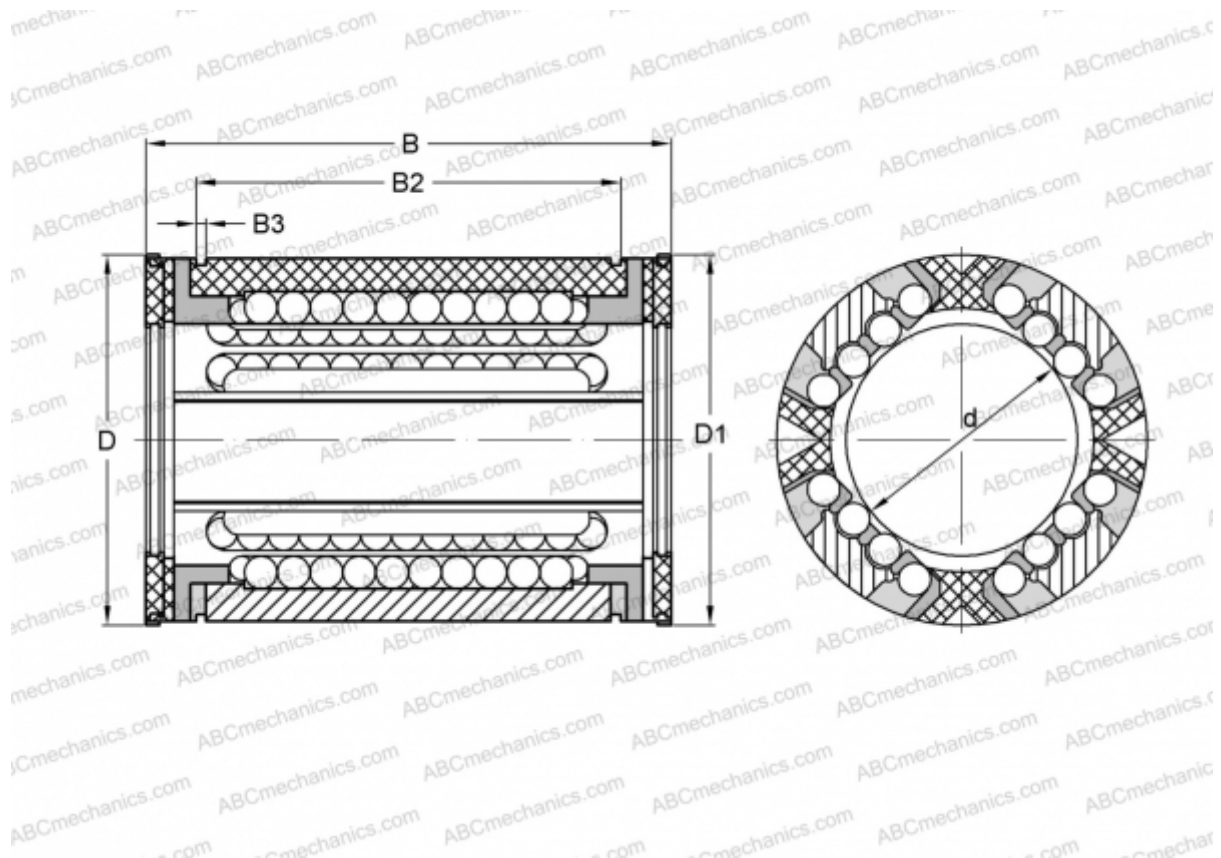

Technical specification

DIMENSIONS, MM

d	40,000
D	62,000
B	80,000
D1	59,400
B2	60,300
B3	2,150

WEIGHT, KG 0,335

MANUFACTURER [INA](#)