

KX16-PP INA

Linear bushing

TYPE: Shaft guidance systems, Linear bushing, Self aligning, Close type, Type KX..PP, heavy duty range, sealed on both sides, inch size (INA)

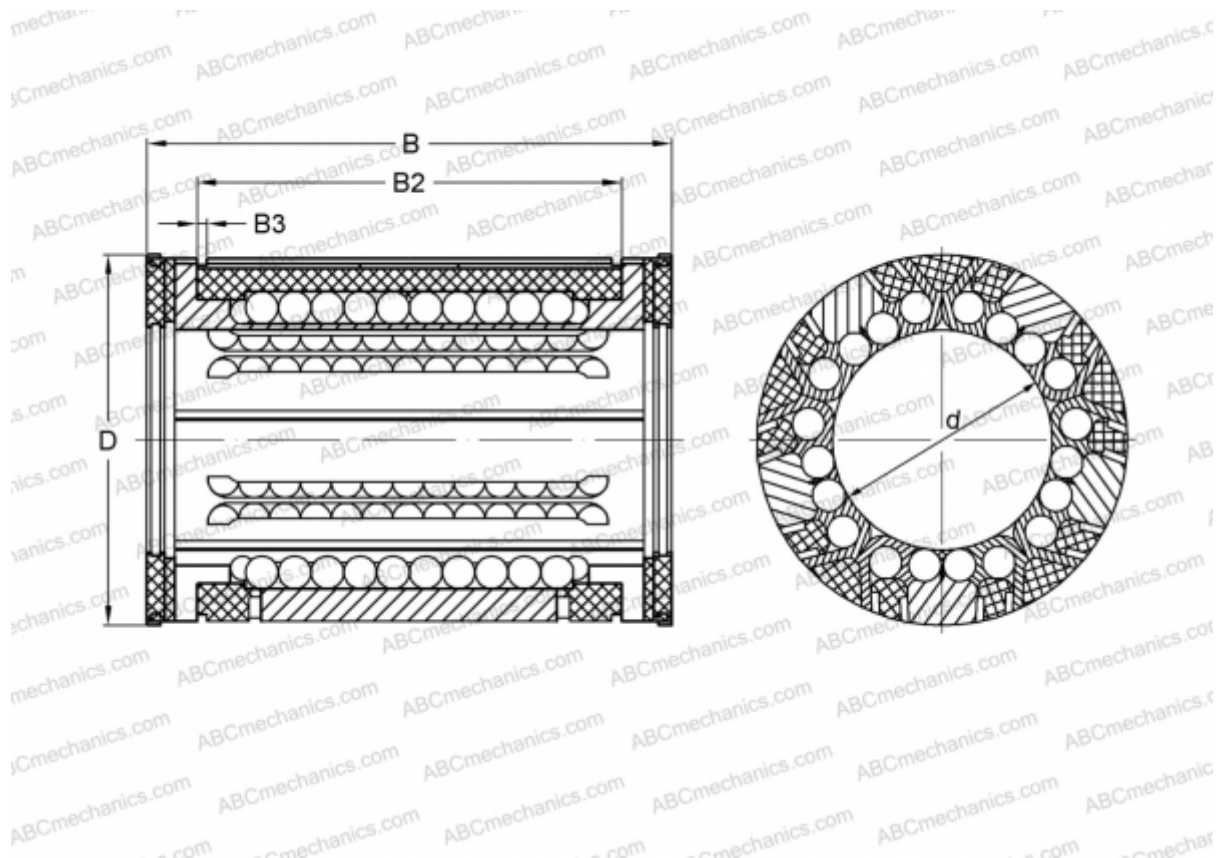

Technical specification

DIMENSIONS, MM

d	25,400
D	39,688
B	57,150
B2	47,904
B3	1,727

WEIGHT, KG 0,111

MANUFACTURER [INA](#)