

KX20-PP INA

Linear bushing

TYPE: Shaft guidance systems, Linear bushing, Self aligning, Close type, Type KX..PP, heavy duty range, sealed on both sides, inch size (INA)

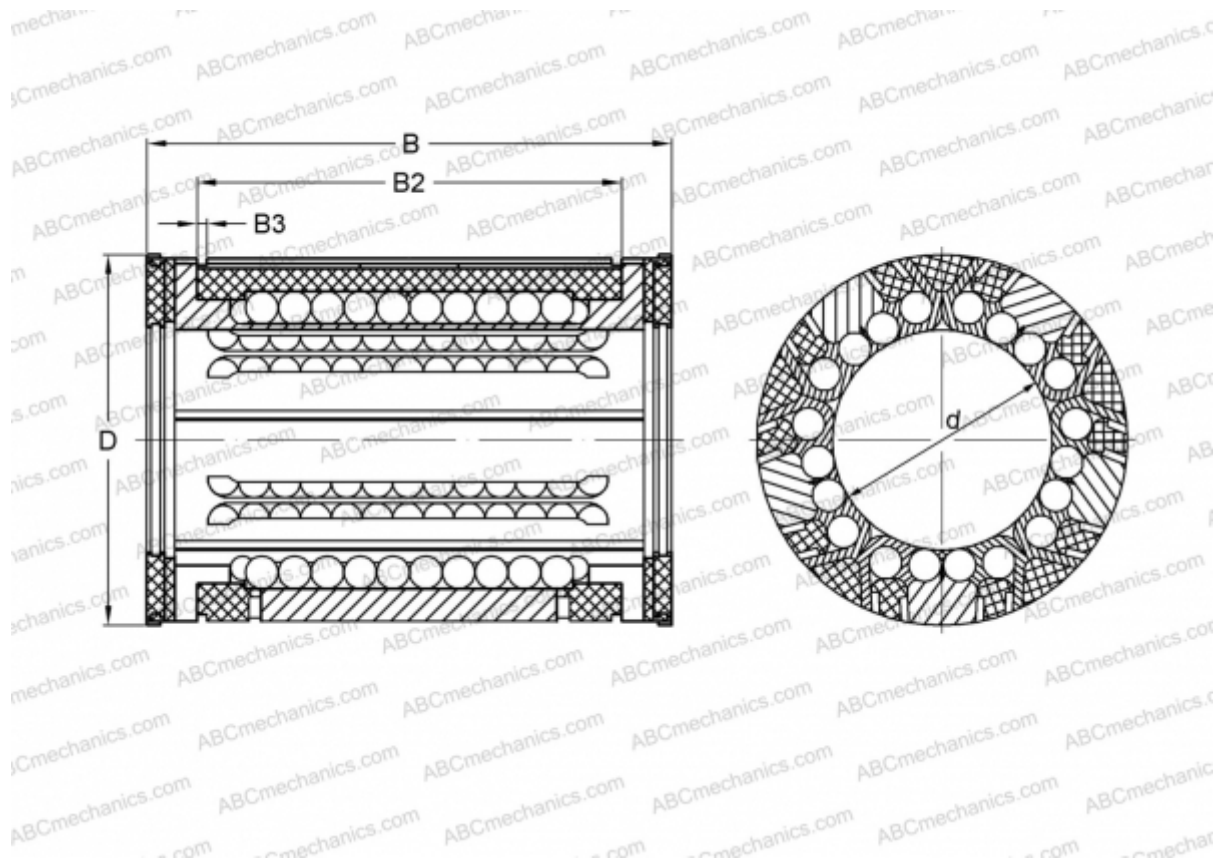

Technical specification

DIMENSIONS, MM

d	31,750
D	50,800
B	66,675
B2	51,079
B3	1,727

WEIGHT, KG 0,215

MANUFACTURER [INA](#)