

## KX24-PP INA

Linear bushing

TYPE: Shaft guidance systems, Linear bushing, Self aligning, Close type, Type KX..PP, heavy duty range, sealed on both sides, inch size (INA)

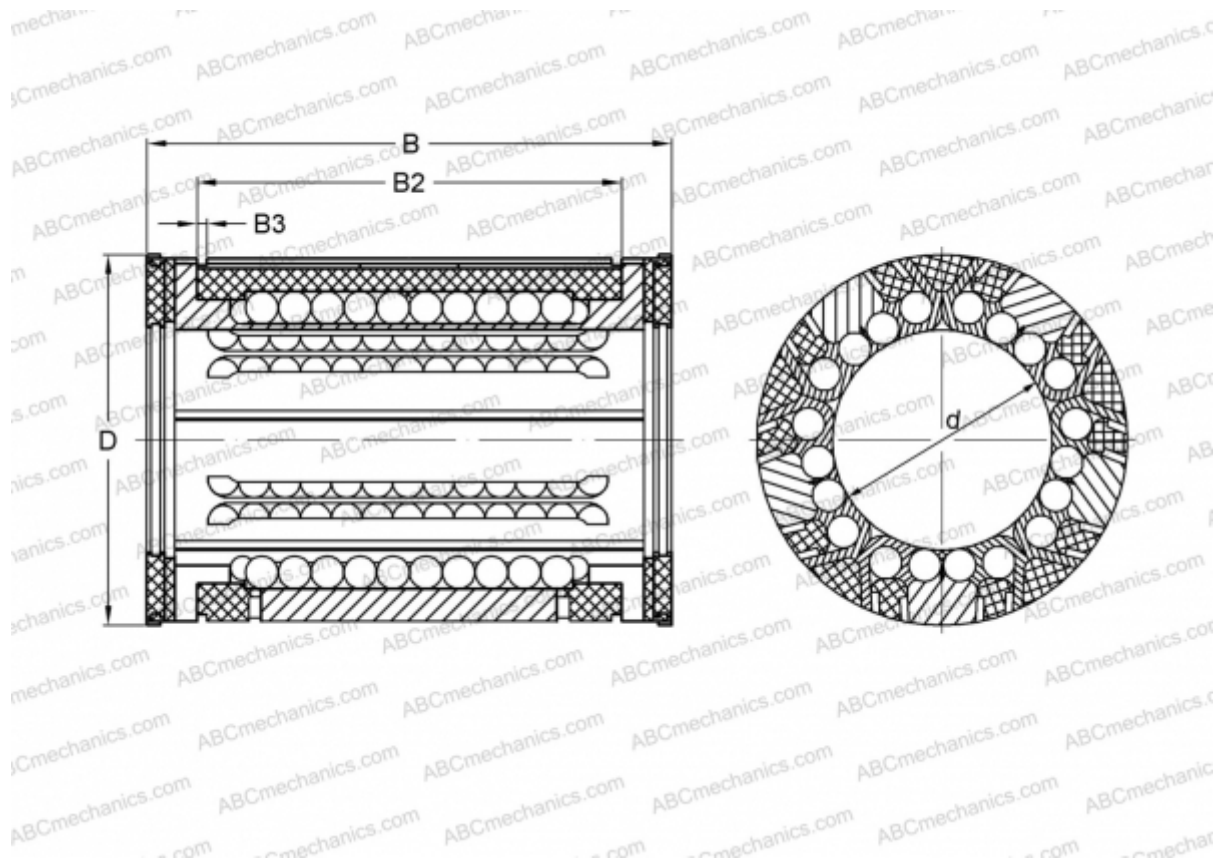

### Technical specification

#### DIMENSIONS, MM

d	38,100
D	60,325
B	76,200
B2	61,519
B3	2,184

**WEIGHT, KG** 0,349

**MANUFACTURER** [INA](#)