

## KBS12-PP-AS INA

Linear bushing

TYPE: Shaft guidance systems, Linear bushing, Self aligning, Close type, Type KBS..PP-AS, machined range, sealed on both sides, with relubrication facility (INA)

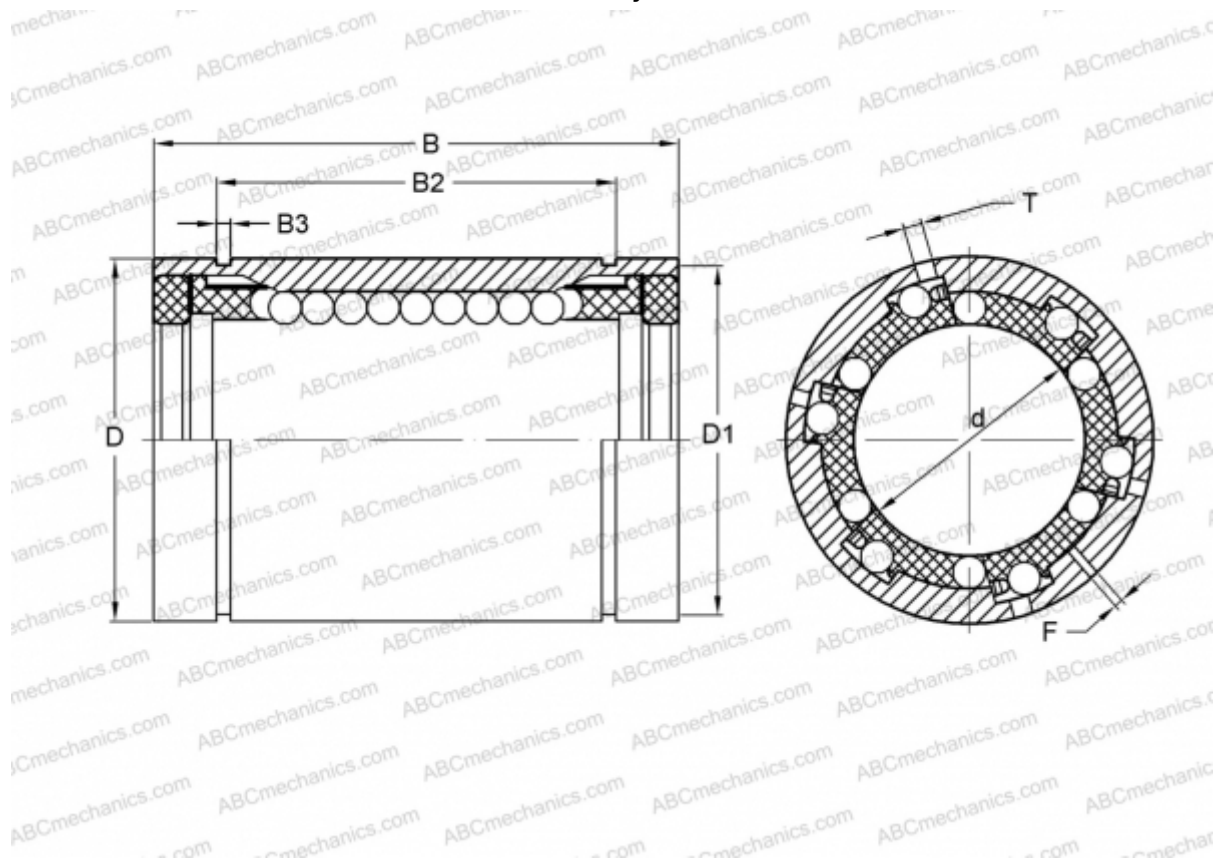

### Technical specification

#### DIMENSIONS, MM

d	12,000
D	22,000
B	32,000
D1	21,000
B2	22,600
B3	1,300
T	1,500
F	1

**WEIGHT, KG** 0,040

**MANUFACTURER** [INA](#)