

## KBS16-PP-AS INA

Linear bushing

TYPE: Shaft guidance systems, Linear bushing, Self aligning, Close type, Type KBS..PP-AS, machined range, sealed on both sides, with relubrication facility (INA)

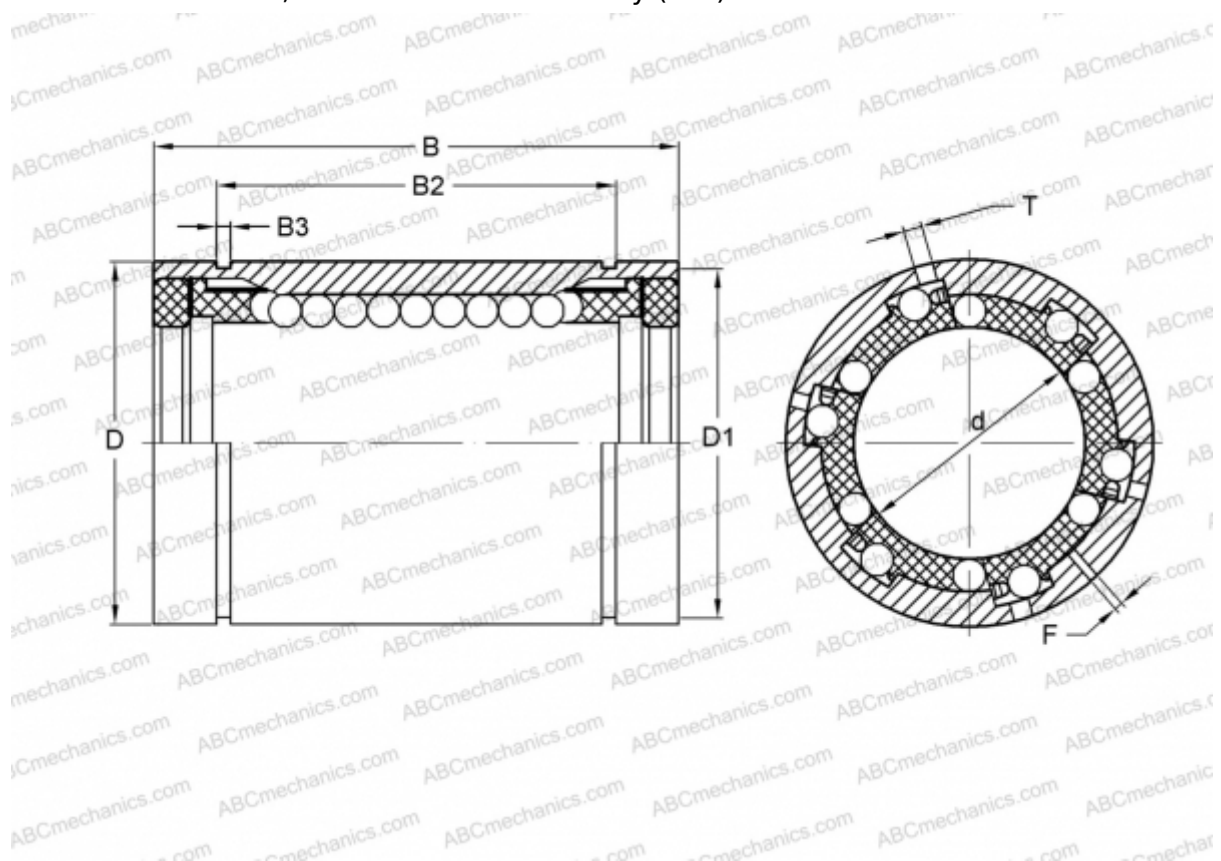

### Technical specification

#### DIMENSIONS, MM

d	16,000
D	26,000
B	36,000
D1	24,900
B2	24,600
B3	1,300
T	2,000
F	1

**WEIGHT, KG** 0,050

**MANUFACTURER** [INA](#)