

## KBS20-PP-AS INA

Linear bushing

TYPE: Shaft guidance systems, Linear bushing, Self aligning, Close type, Type KBS..PP-AS, machined range, sealed on both sides, with relubrication facility (INA)

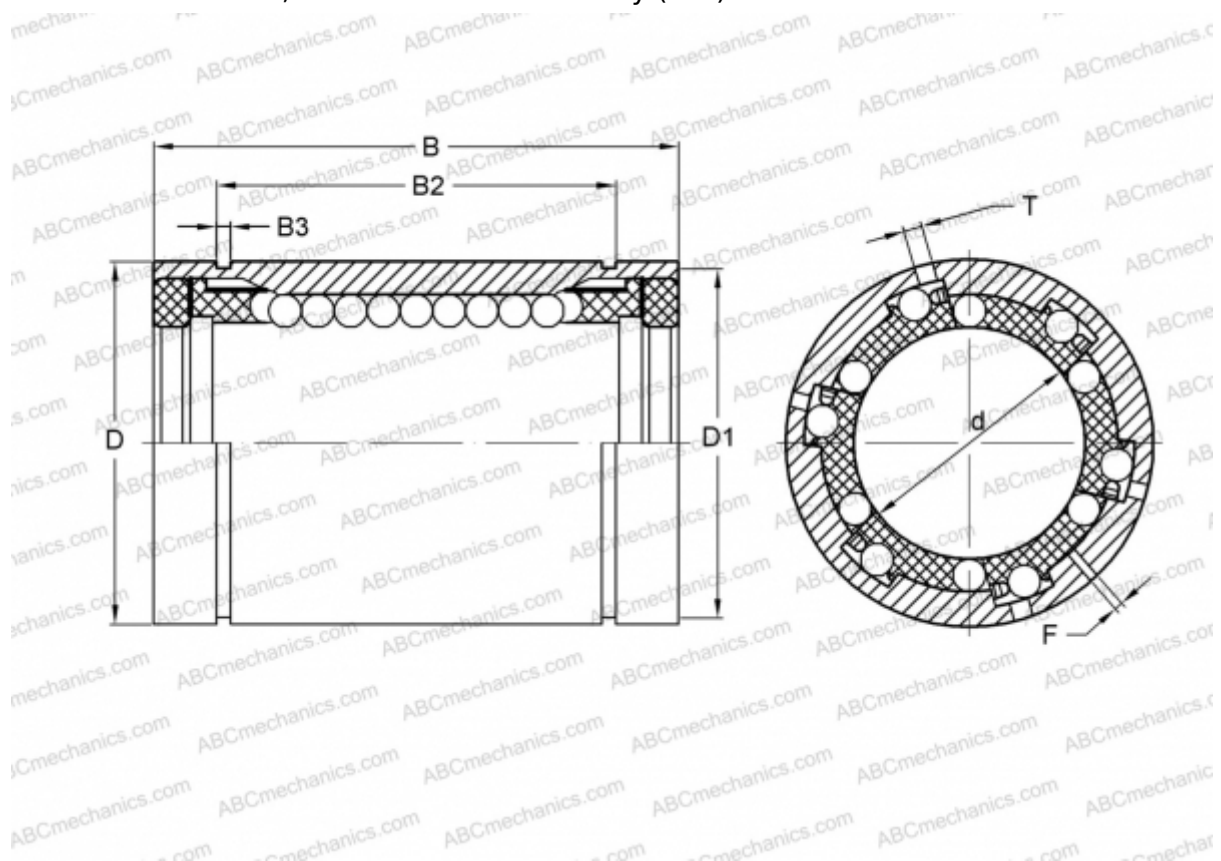

### Technical specification

#### DIMENSIONS, MM

d	20,000
D	32,000
B	45,000
D1	30,300
B2	31,200
B3	1,600
T	2,000
F	1

**WEIGHT, KG** 0,090

**MANUFACTURER** [INA](#)