

KBS40-PP-AS INA

Linear bushing

TYPE: Shaft guidance systems, Linear bushing, Self aligning, Close type, Type KBS..PP-AS, machined range, sealed on both sides, with relubrication facility (INA)

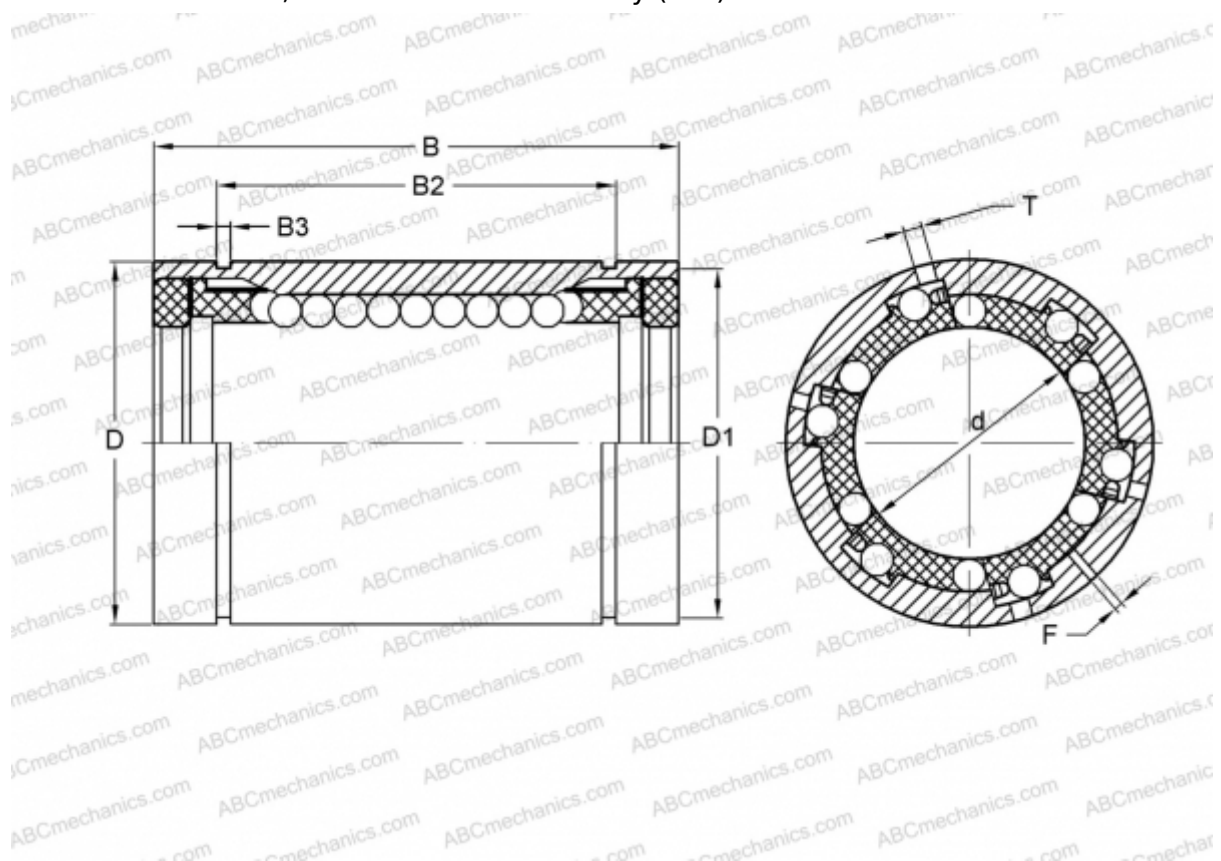

Technical specification

DIMENSIONS, MM

d	40,000
D	62,000
B	80,000
D1	59,000
B2	60,300
B3	2,150
T	3,000
F	1

WEIGHT, KG 0,600

MANUFACTURER [INA](#)